

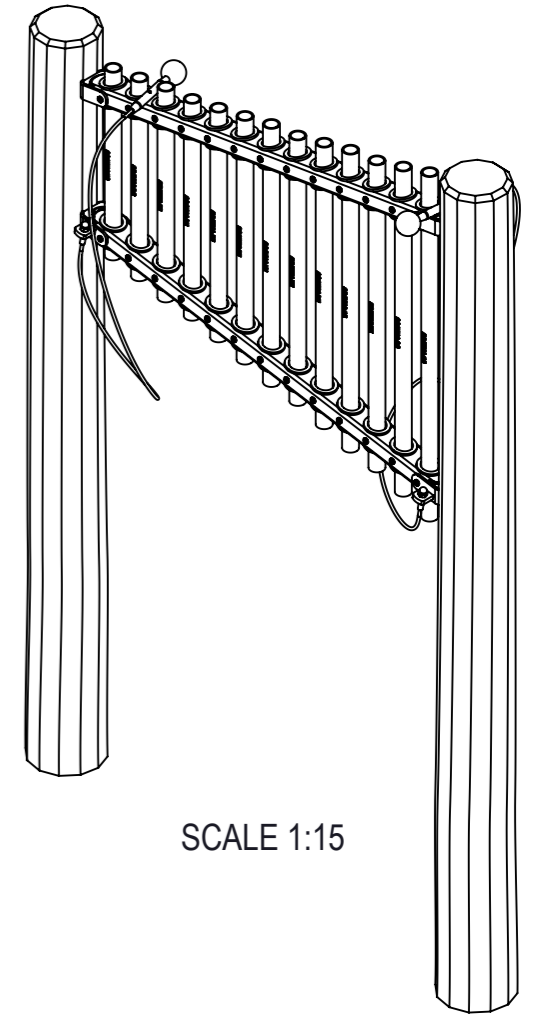

All rights reserved. Reproduction or distribution of this drawing without the written consent of the author is prohibited.

All rechten voorbehouden. Het verspreiden of kopiëren van deze tekening zonder schriftelijke toestemming van de auteur is strafbaar.

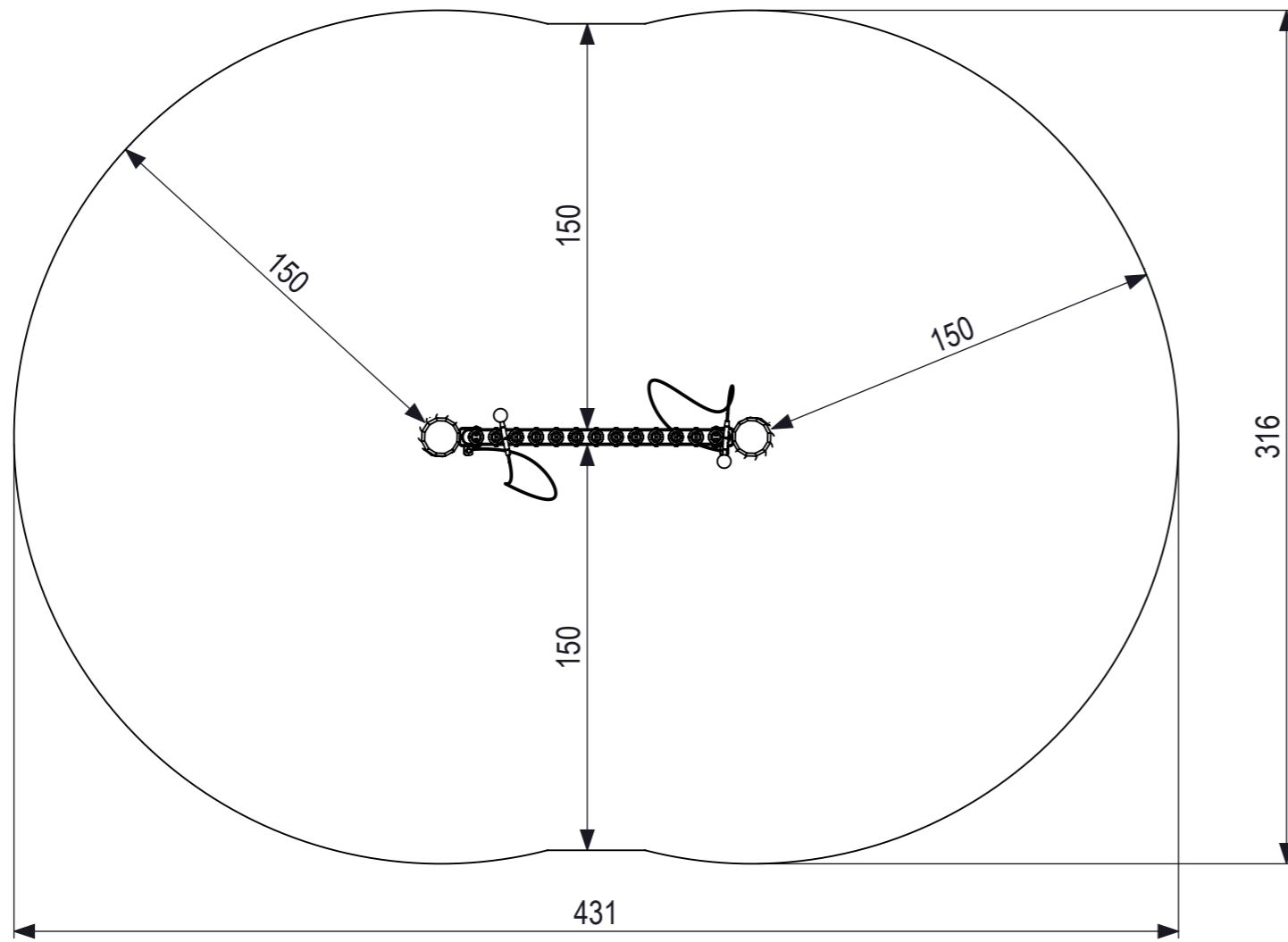
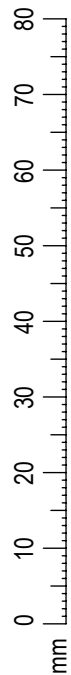
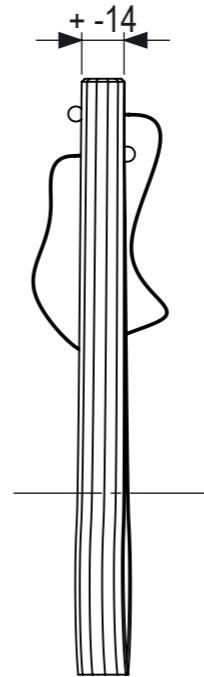
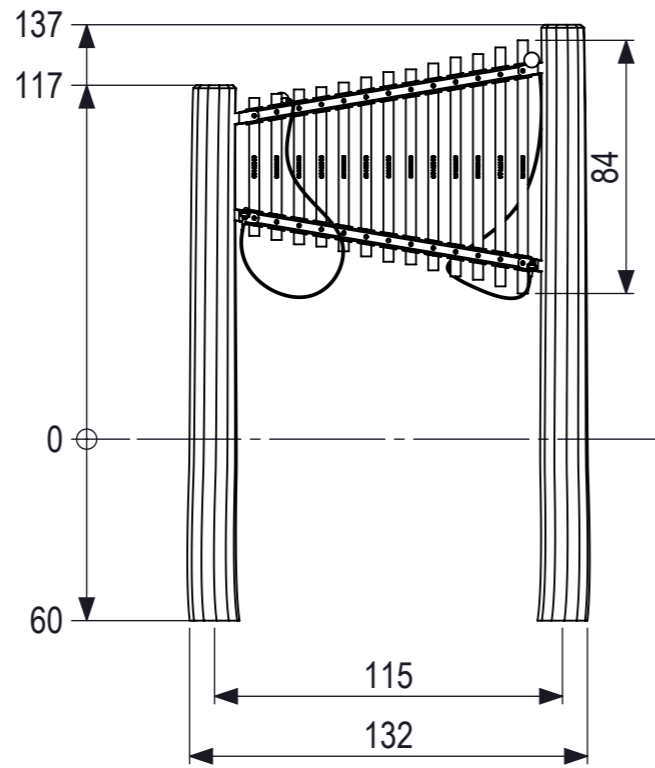

SCALE 1:15



 IJSLANDER Ijslander BV Oude Dijk 10 8096 RK Oldebroek The Netherlands T +31 (0)525 633420 F +31 (0)525 631067 info@ijslander.com www.ijslander.com	oppervlakte ruwheid surface roughness DIN ISO 1302	<input checked="" type="checkbox"/> <input checked="" type="checkbox"/> <input checked="" type="checkbox"/>	alg. ruwheid gen. roughness 3.2	eenheid/unit cm	datum date 14-9-2023	naam name SK																																	
	vorm- en plaatoleranties geometrical tolerancing DIN ISO 1101	<input type="checkbox"/> <input type="checkbox"/> <input type="checkbox"/> <input type="checkbox"/> <input type="checkbox"/> <input type="checkbox"/>	<input type="checkbox"/> <input type="checkbox"/> <input type="checkbox"/> <input type="checkbox"/>	norm EN 1176:2017	toelaatbare afwijkingen voor lineaire maten (m.u.v. gebroken kanten) admissible deviations for linear dimensions (excepting broken edges)																																		
alg. toleranties gen. tolerancing DIN 7168-m	<table border="1"> <tr> <td>lineaire maat</td> <td>></td> <td>0,5</td> <td>6</td> <td>30</td> <td>120</td> <td>400</td> <td>1000</td> <td>2000</td> <td>4000</td> </tr> <tr> <td>linear dimension</td> <td>≤</td> <td>6</td> <td>30</td> <td>120</td> <td>400</td> <td>1000</td> <td>2000</td> <td>4000</td> <td>8000</td> </tr> <tr> <td>afwijking/deviation</td> <td></td> <td>±0.1</td> <td>±0.2</td> <td>±0.3</td> <td>±0.5</td> <td>±0.8</td> <td>±1.2</td> <td>±2</td> <td>±3</td> </tr> </table>			lineaire maat	>	0,5	6	30	120	400	1000	2000	4000	linear dimension	≤	6	30	120	400	1000	2000	4000	8000	afwijking/deviation		±0.1	±0.2	±0.3	±0.5	±0.8	±1.2	±2	±3	Totaal gewicht: 65 kg Zwaarste onderdeel: 25.34 kg	Leefijd van: 6 - 12 jaar Valondergrond klasse: A - Geen valondergrond benodigd	tekeningnummer/drawingnumber 1756-01-INS	blad/sheet 2 - 2	wijz./rev. 00	form./size A3
lineaire maat	>	0,5	6	30	120	400	1000	2000	4000																														
linear dimension	≤	6	30	120	400	1000	2000	4000	8000																														
afwijking/deviation		±0.1	±0.2	±0.3	±0.5	±0.8	±1.2	±2	±3																														
proj. 	omschrijving/description Melody Mingle Vivaldi - vario			schaal/scale 1:25																																			