

NORLEG	
Sørøverskib	
Z50943	
23.06.2017	REV. -

< 1400

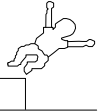

≥ EN 1176

Ijlander rev. 6673

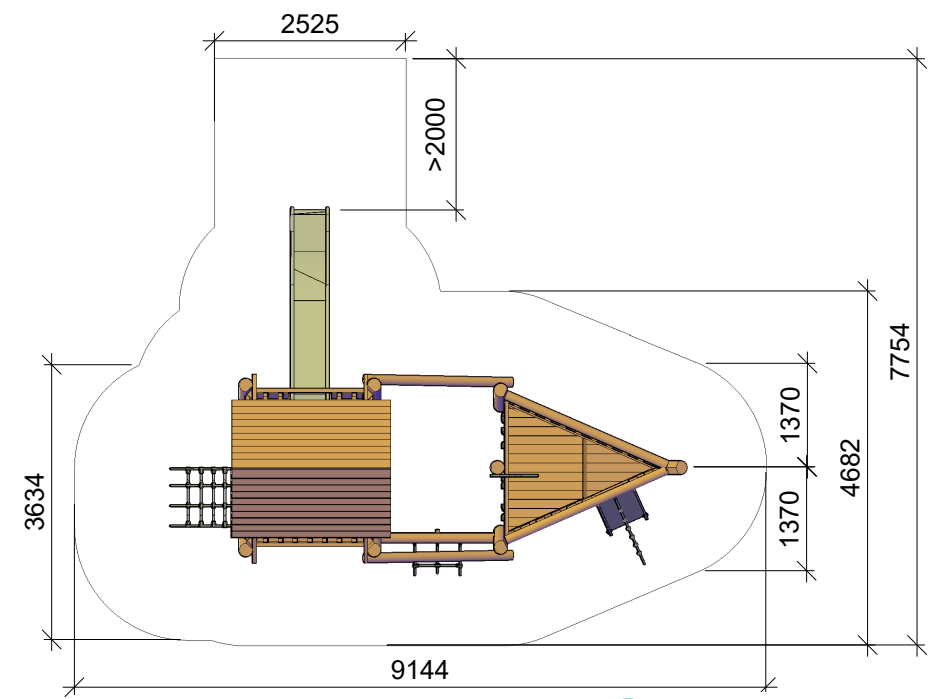
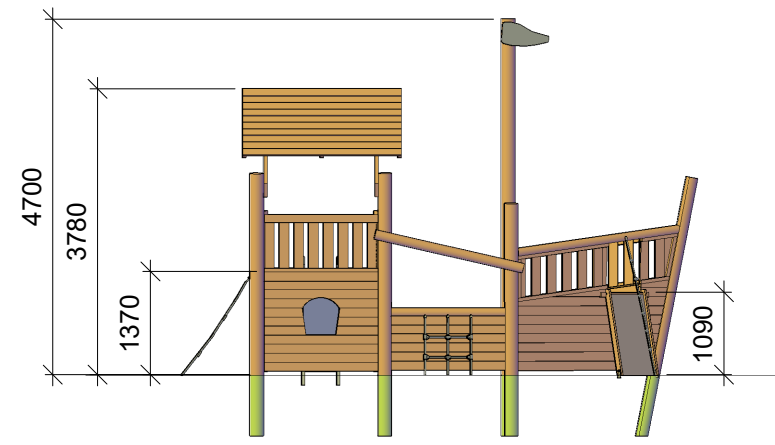

This drawing is the property of NORLEG and pursuant to current legislation may not be copied, transferred to or used by any third party. Should this drawing be used, a fee of 10% of the assumed contract price will be charged.

1:100

NORLEG	
Sørøverskip	
Z50943	
23.06.2017	REV. -



This drawing is the property of NORLEG and pursuant to current legislation may not be copied, transferred to or used by any third party. Should this drawing be used, a fee of 10% of the assumed contract price will be charged.

NORLEG	
Sørøverskip	
Z50943	
23.06.2017	REV. -

< 1400

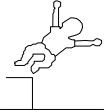

≥ EN 1176

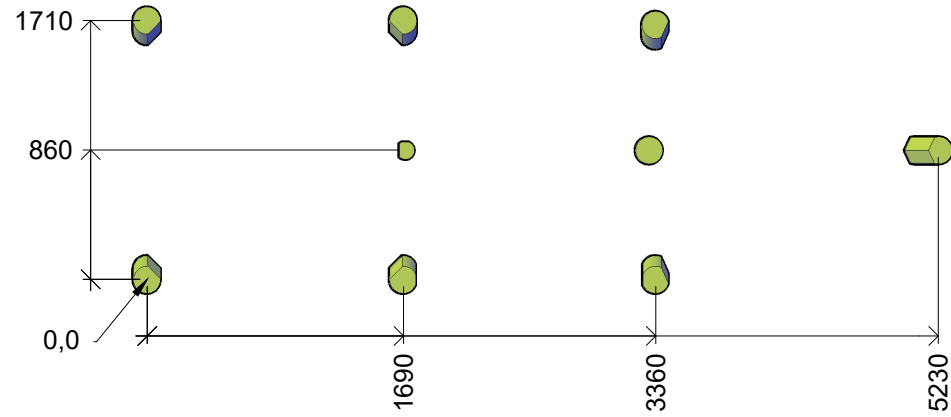
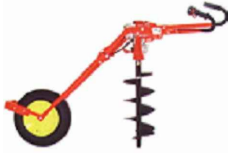

NORLEG	
Sørøverskip	
Z50943	
23.06.2017	REV. -

< 1400

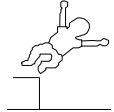

≥ EN 1176

By assembly. Drilling and use of saw must be expected.

Dh = Disk head



- Mont.

Ch = Countersunk head

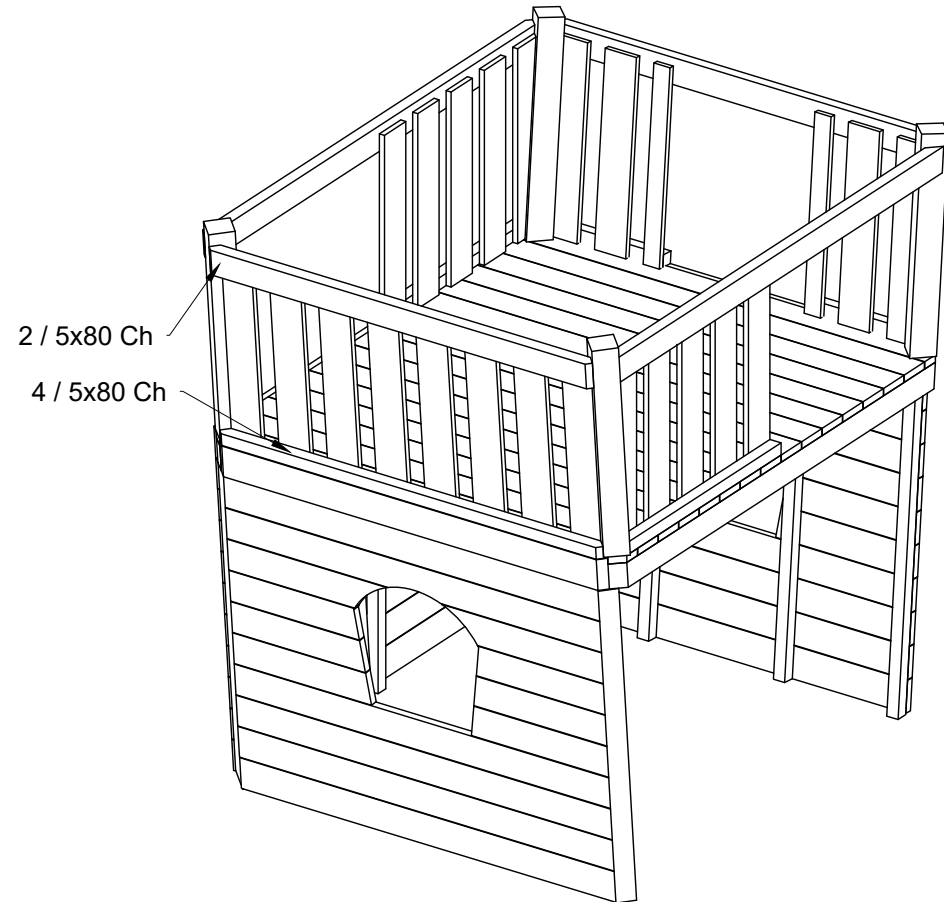
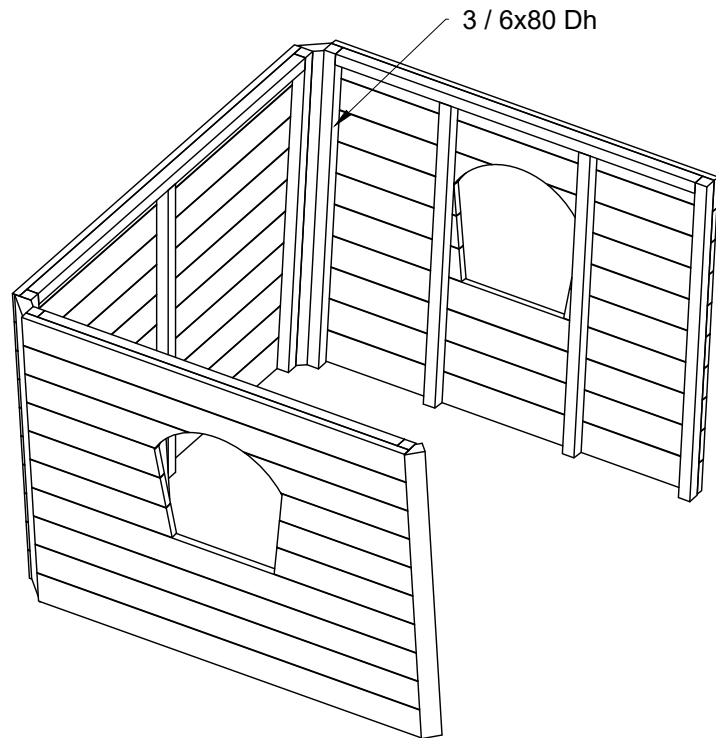
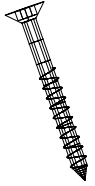

This drawing is the property of NORLEG and pursuant to current legislation may not be copied, transferred to or used by any third party. Should this drawing be used, a fee of 10% of the assumed contract price will be charged.

NORLEG	
Sørøverskip	
Z50943	
23.06.2017	REV. -

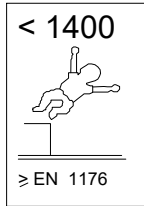

By assembly. Drilling and use of saw must be expected.

Dh = Disk head



Ch = Countersunk head

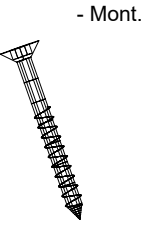

Mont.p. nr.

- 19
- 24A
- 90

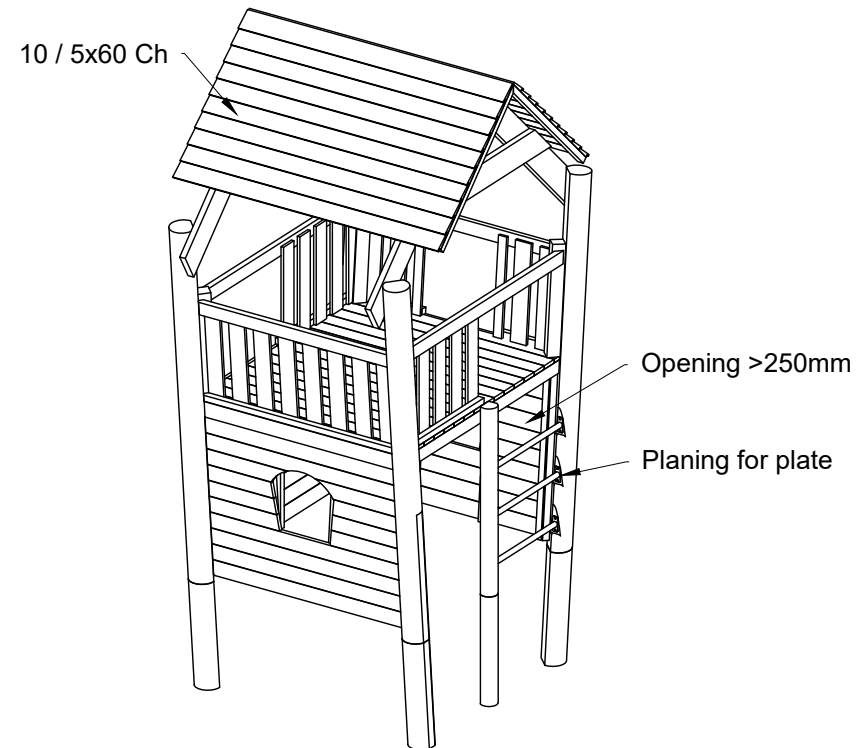
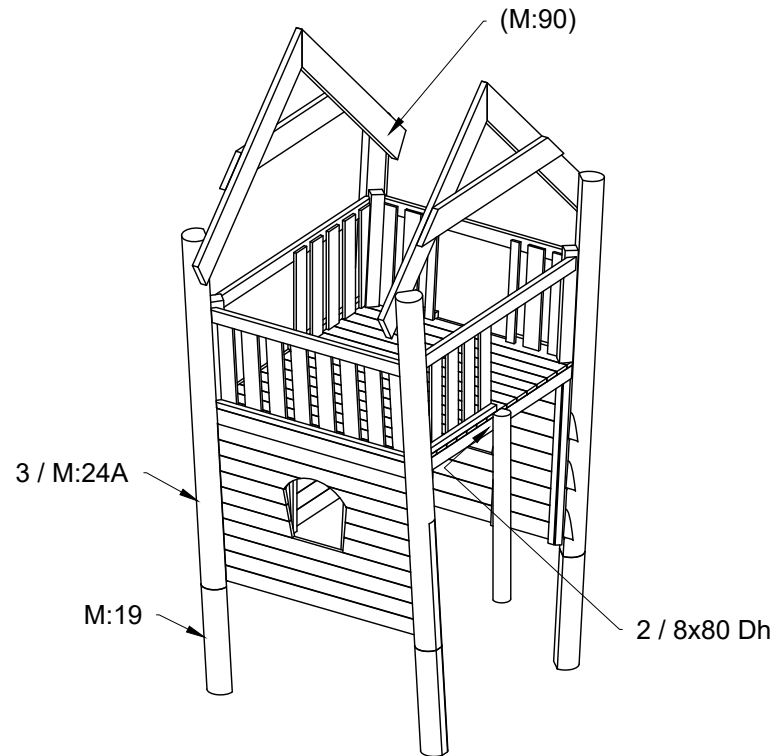

NORLEG	
Sørøverskip	
Z50943	
23.06.2017	REV. -

< 1400



≥ EN 1176

By assembly. Drilling and use of saw must be expected.

Dh = Disk head



Ch = Countersunk head

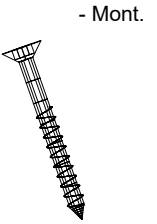

Mont.p. nr.

2

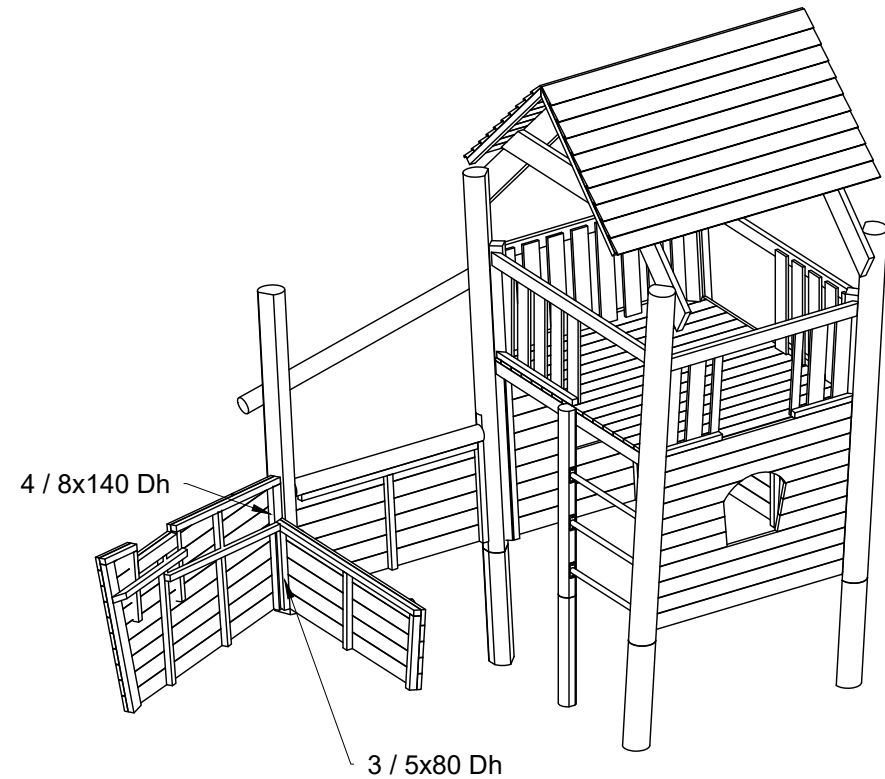
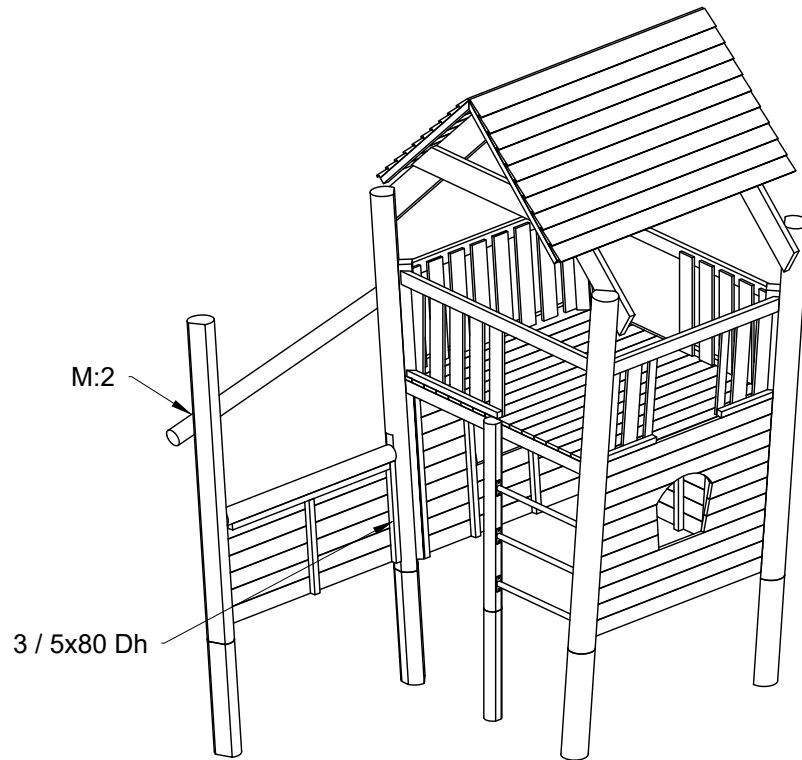

NORLEG	
Sørøverskip	
Z50943	
23.06.2017	REV. -

< 1400

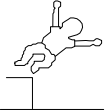

≥ EN 1176

By assembly. Drilling and use of saw must be expected.

Dh = Disk head



- Mont.

Ch = Countersunk head

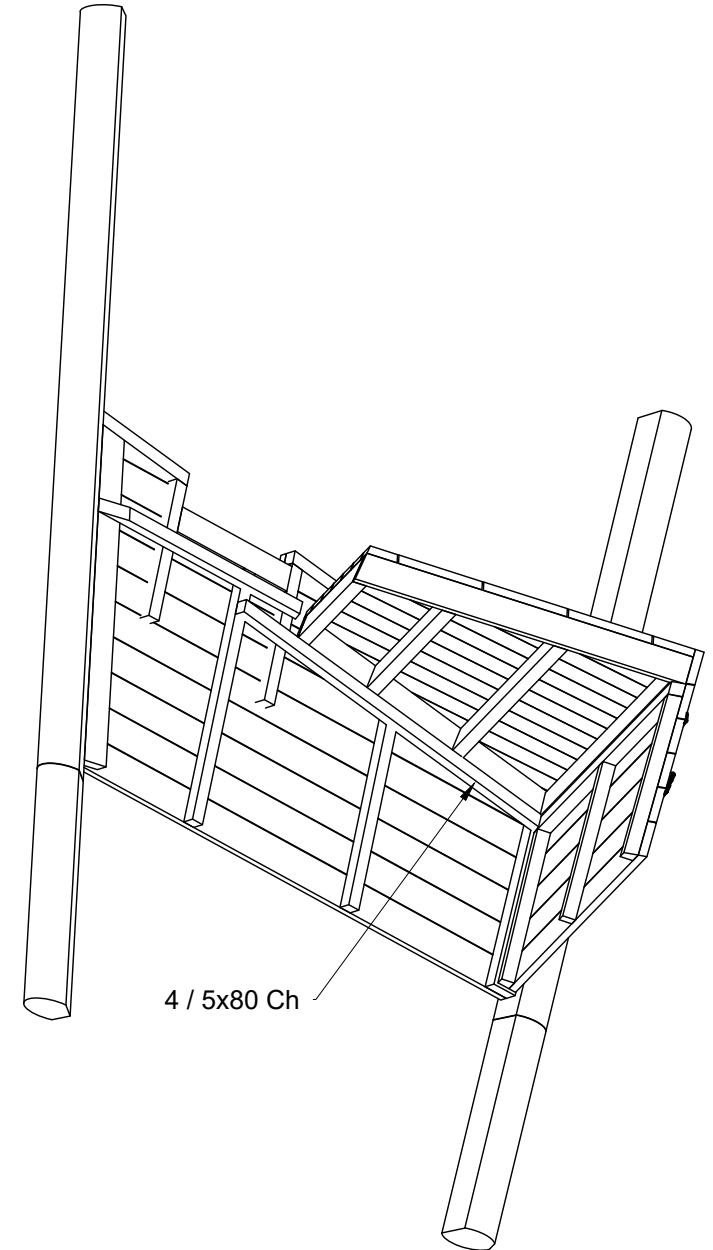
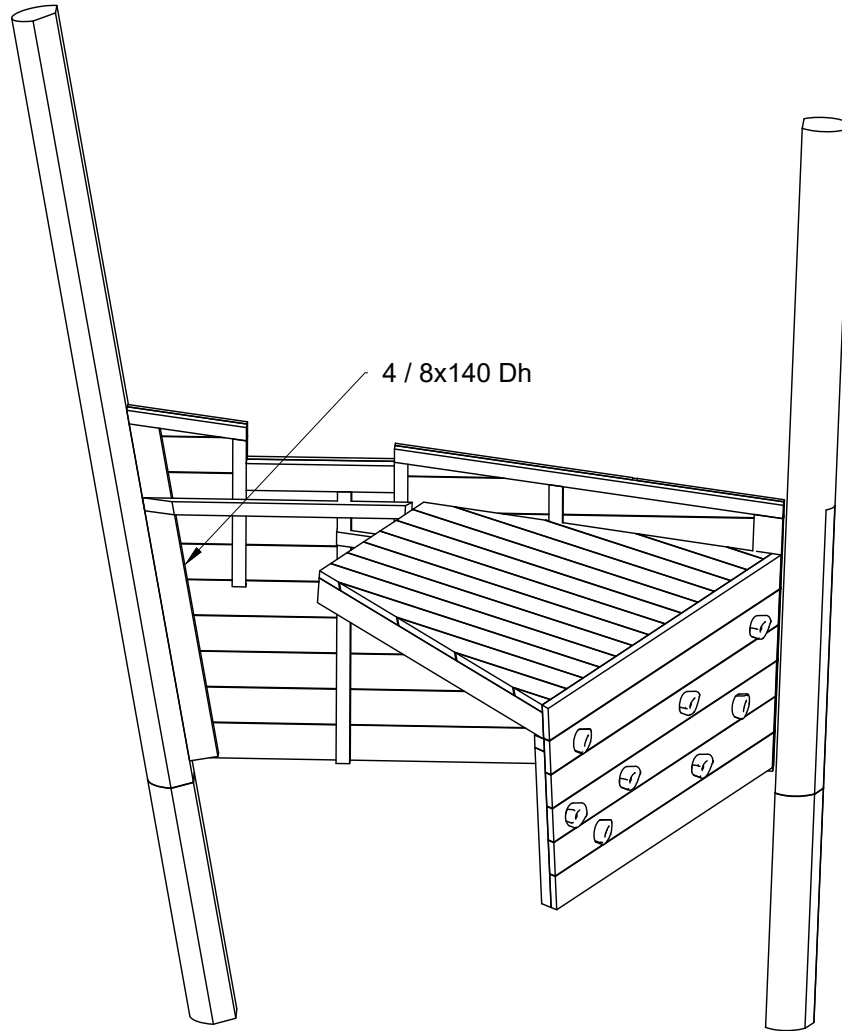
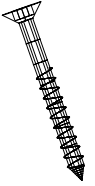

This drawing is the property of NORLEG and pursuant to current legislation may not be copied, transferred to or used by any third party. Should this drawing be used, a fee of 10% of the assumed contract price will be charged.

NORLEG	
Sørøverskip	
Z50943	
23.06.2017	REV. -

< 1400

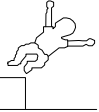

≥ EN 1176

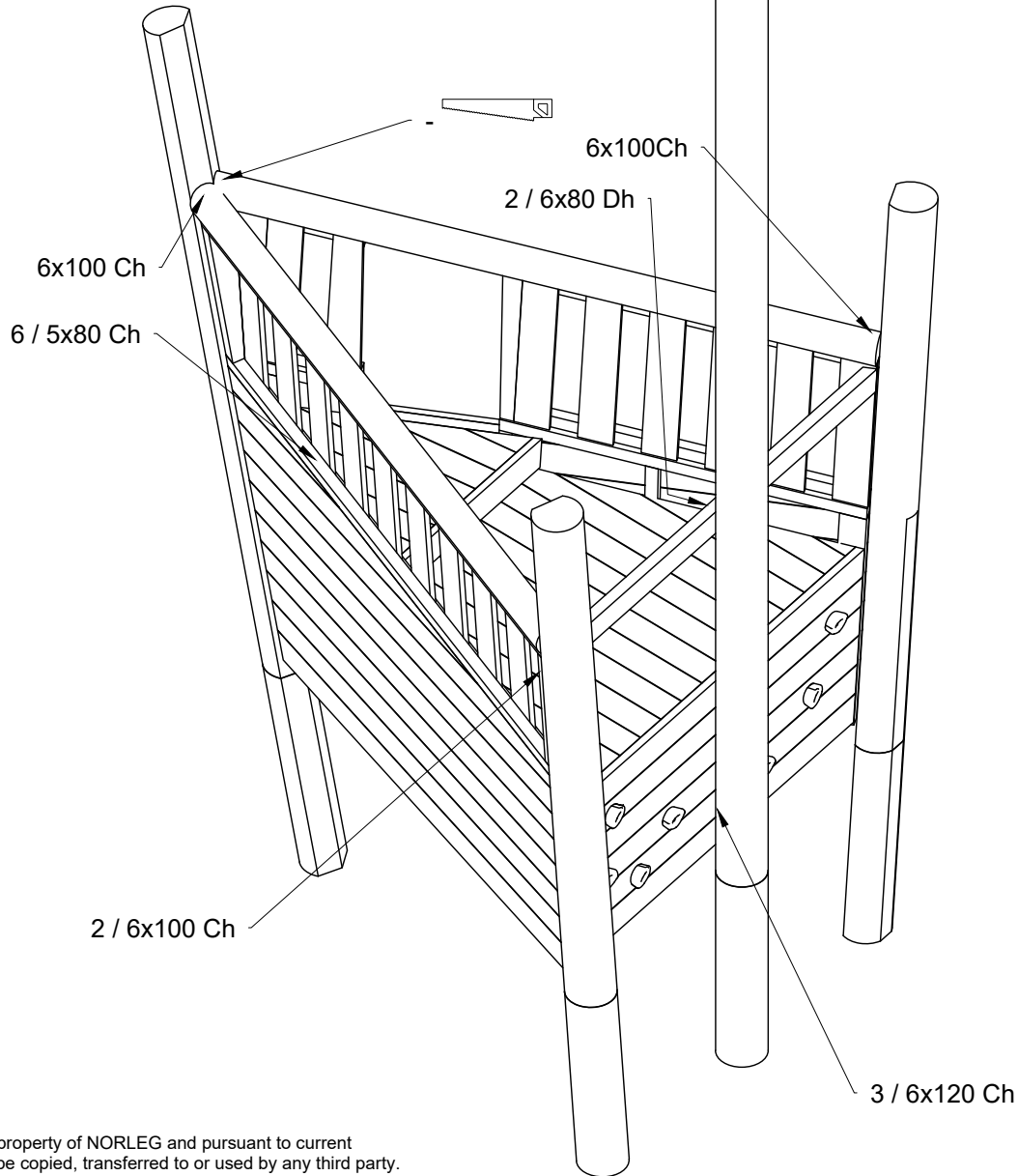

Dh = Disk head



Ch = Countersunk head

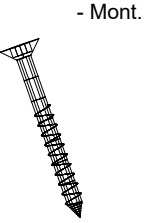

By assembly. Drilling and use of saw must be expected.

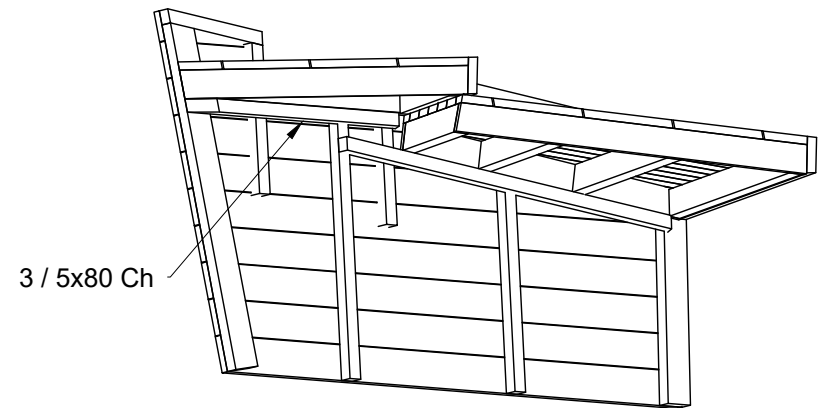

This drawing is the property of NORLEG and pursuant to current legislation may not be copied, transferred to or used by any third party. Should this drawing be used, a fee of 10% of the assumed contract price will be charged.

NORLEG	
Sørøverskip	
Z50943	
23.06.2017	REV. -

< 1400



≥ EN 1176

By assembly. Drilling and use of saw must be expected.

Dh = Disk head

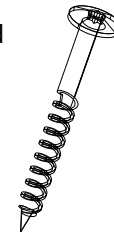

- Mont.

Ch = Countersunk head

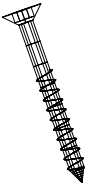

Mont.p. nr.

- 2
- 4
- 22
- 24A
- 52A
- 56A

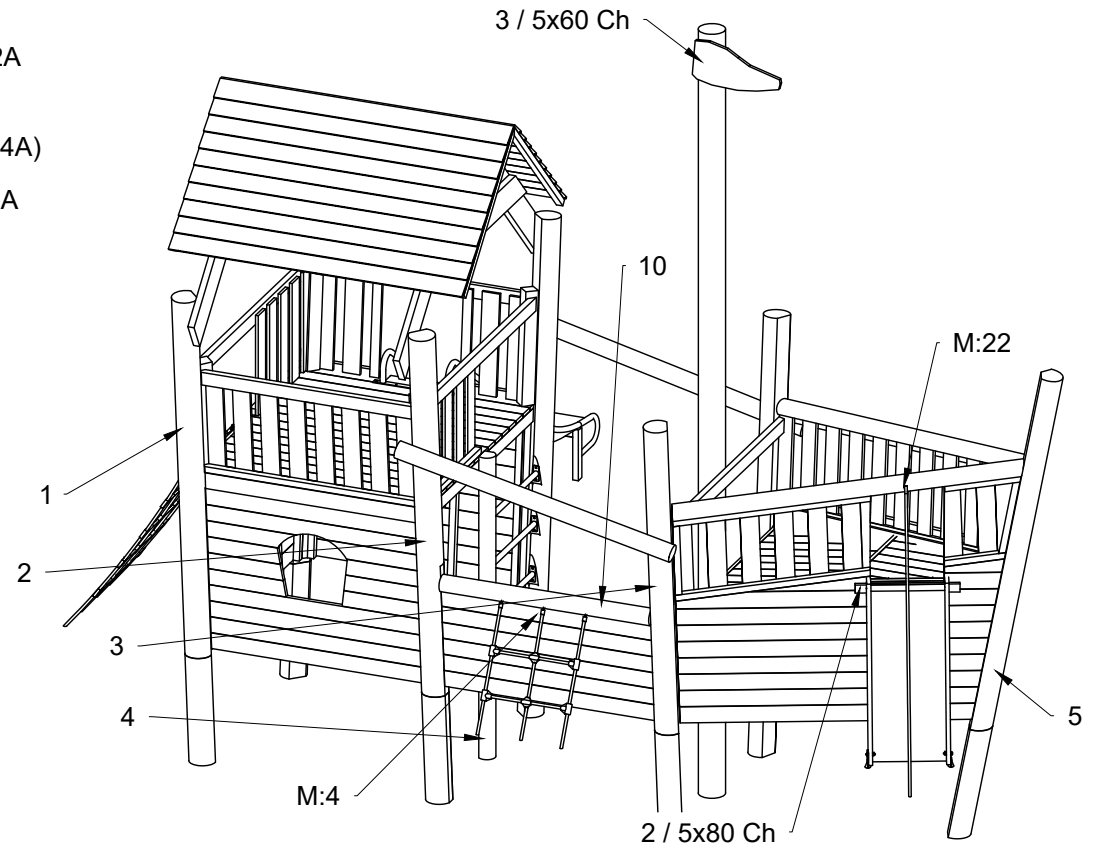
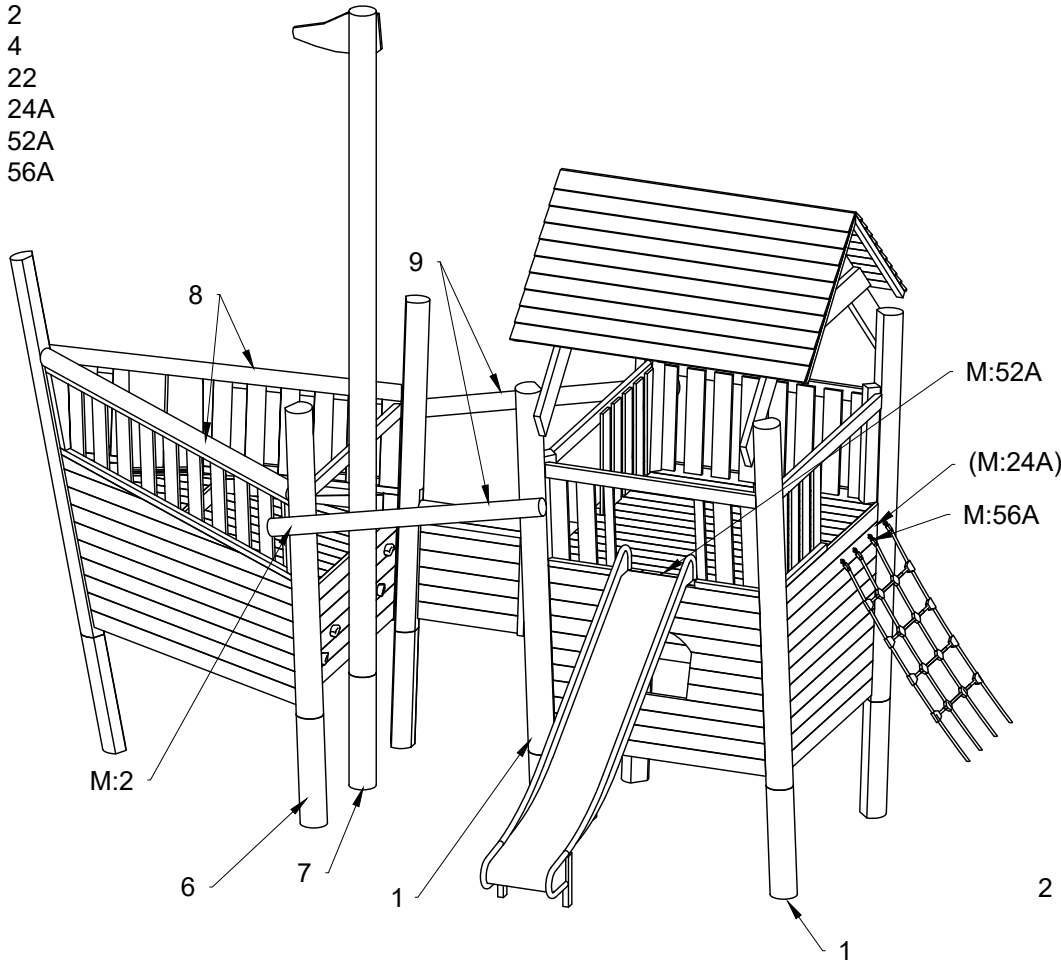

This drawing is the property of NORLEG and pursuant to current legislation may not be copied, transferred to or used by any third party. Should this drawing be used, a fee of 10% of the assumed contract price will be charged.

NORLEG

Sørøverskip

Z50943

23.06.2017

REV. -

< 1400

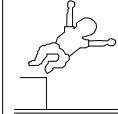

≥ EN 1176

By assembly. Drilling and use of saw must be expected.

Dh = Disk head

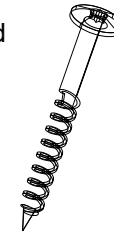

Ch = Countersunk head

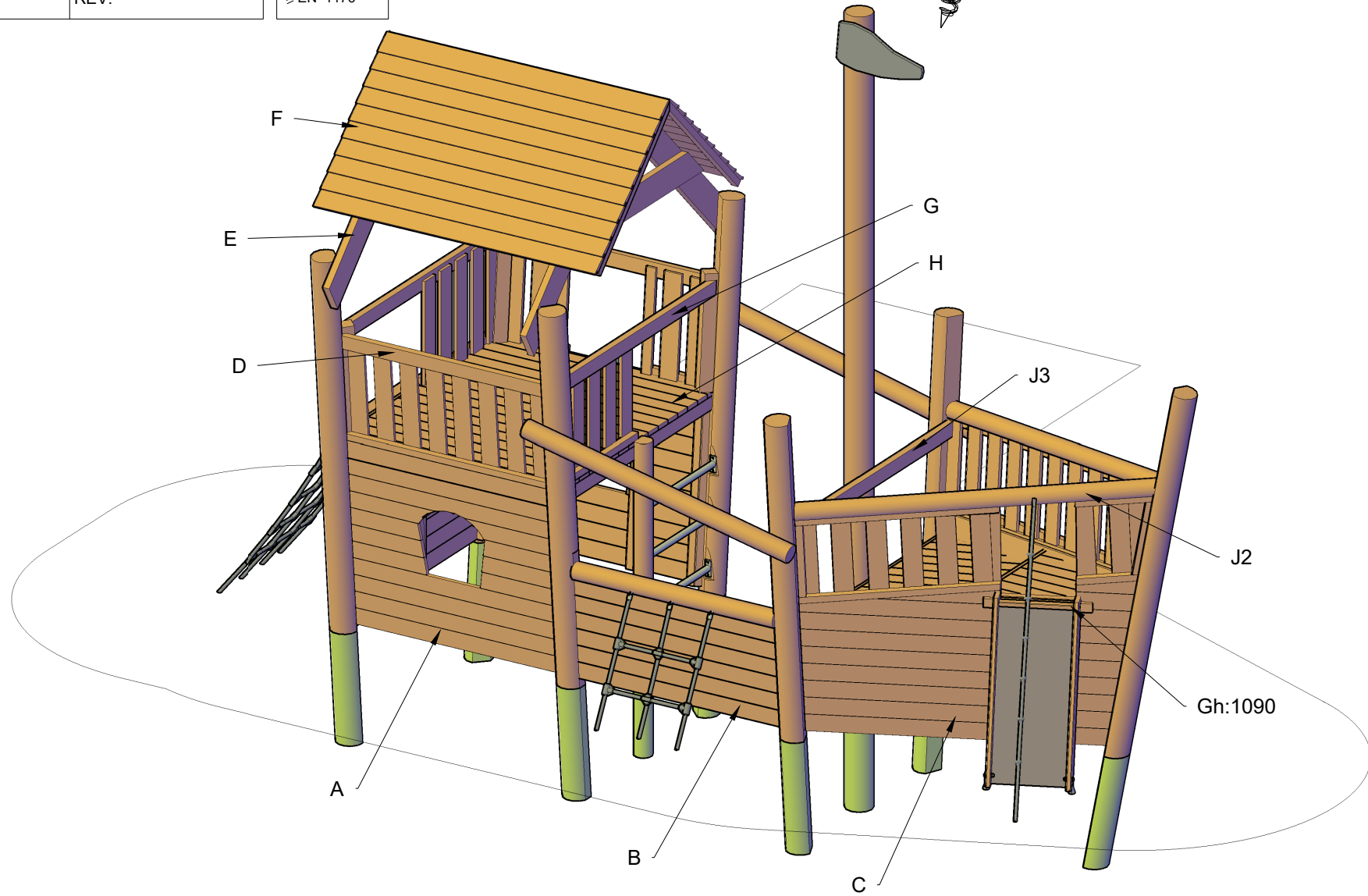
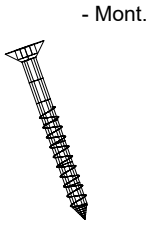

NORLEG	
Sørøverskip	
Z50943	
23.06.2017	REV. -

< 1400

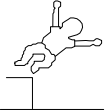

≥ EN 1176

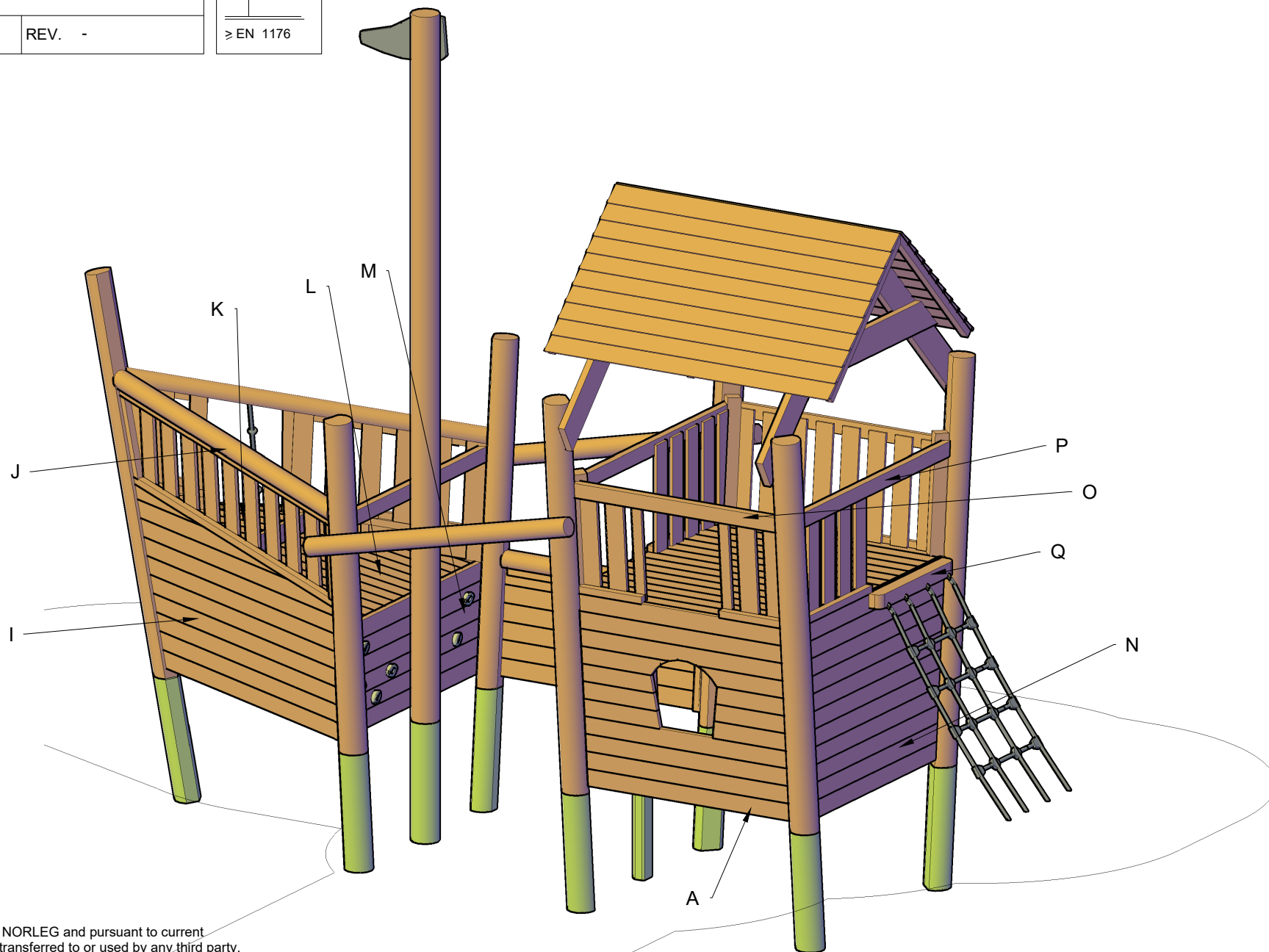

This drawing is the property of NORLEG and pursuant to current legislation may not be copied, transferred to or used by any third party. Should this drawing be used, a fee of 10% of the assumed contract price will be charged.

NORLEG	
Sørøverskip	
Z50943	
23.06.2017	REV. -

< 1400

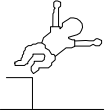

≥ EN 1176



This drawing is the property of NORLEG and pursuant to current legislation may not be copied, transferred to or used by any third party. Should this drawing be used, a fee of 10% of the assumed contract price will be charged.