

<b>NORLEG</b>	
Klatresystem Brokk	
Z12711	
Dato 22.06.2017	REV. -

< 2500



≥ EN 1176

Ijlander rev. 6667

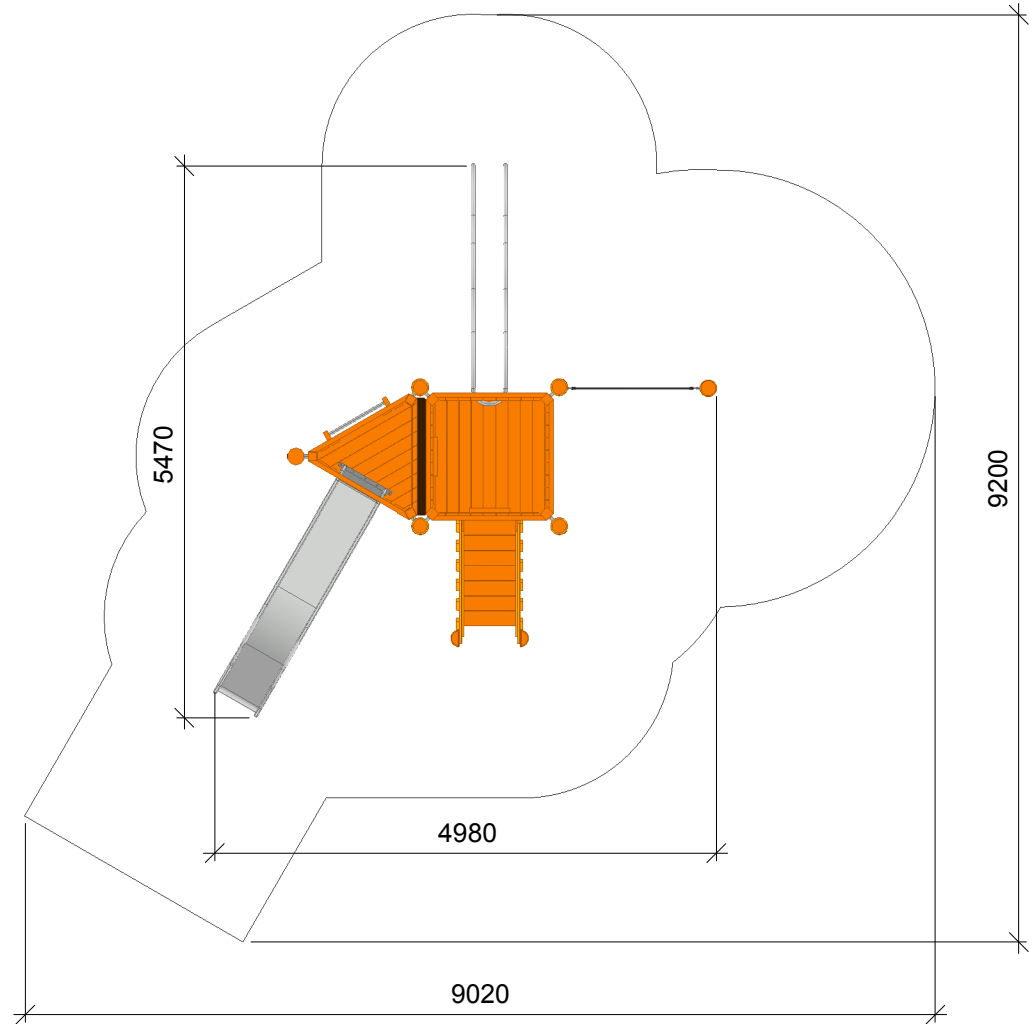
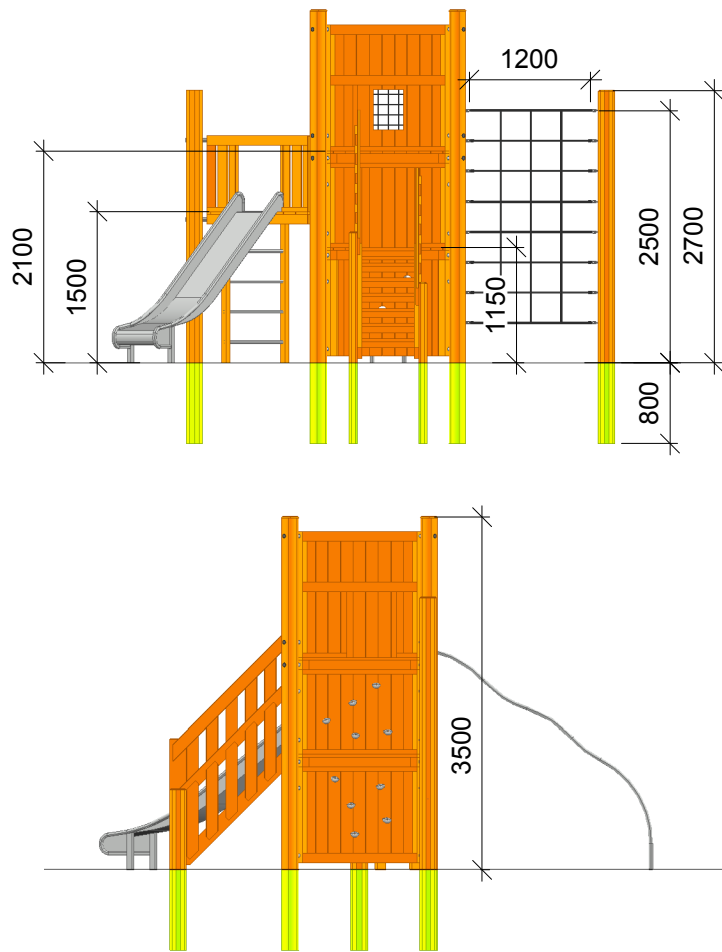

This drawing is the property of NORLEG and pursuant to current legislation may not be copied, transferred to or used by any third party. Should this drawing be used, a fee of 10% of the assumed contract price will be charged.

1:75



Ijlander BV  
 Oude Dijk 10  
 8096 RK Oldebroek | The Netherlands  
 T +31 (0)525 633420 | F +31 (0)525 631067  
 info@ijlander.com | www.ijlander.com

<b>NORLEG</b>	
<b>Klatresystem Brokk</b>	
Z12711	
Dato 22.06.2017	REV. -

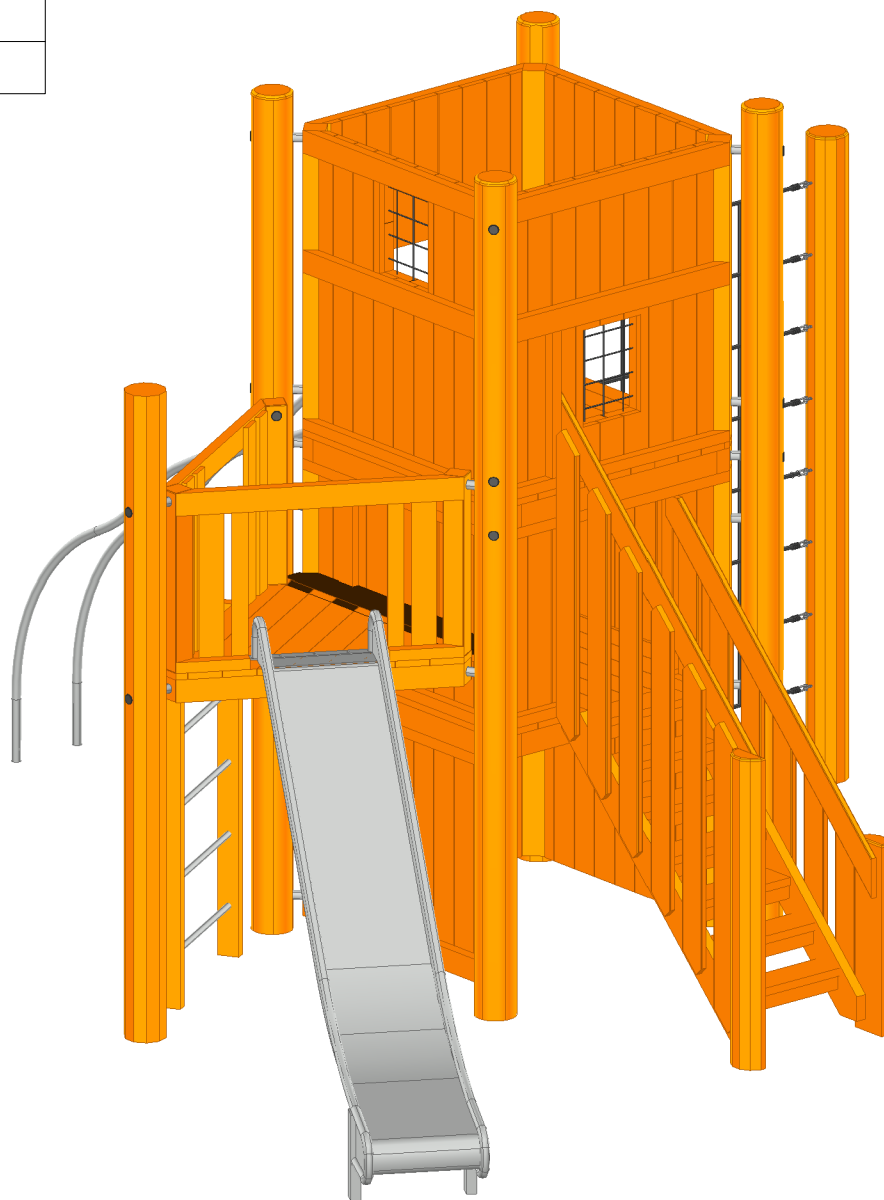

This drawing is the property of NORLEG and pursuant to current legislation may not be copied, transferred to or used by any third party. Should this drawing be used, a fee of 10% of the assumed contract price will be charged.

<b>NORLEG</b>	
<b>Klatresystem Brokk</b>	
Z12711	
Dato 22.06.2017	REV. -

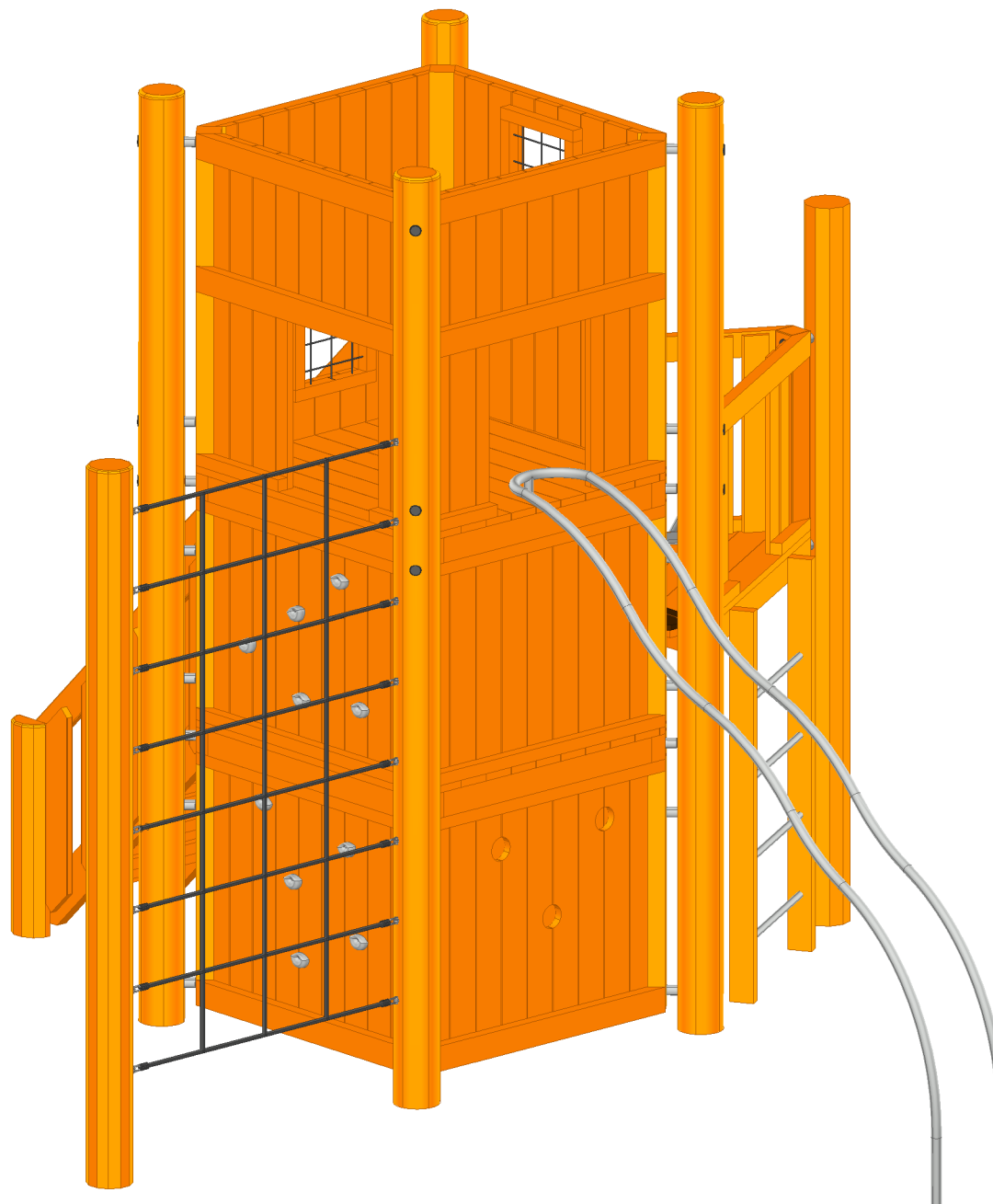

This drawing is the property of NORLEG and pursuant to current legislation may not be copied, transferred to or used by any third party. Should this drawing be used, a fee of 10% of the assumed contract price will be charged.

<b>NORLEG</b>	
<b>Klatresystem Brokk</b>	
Z12711	
Dato 22.06.2017	REV. -

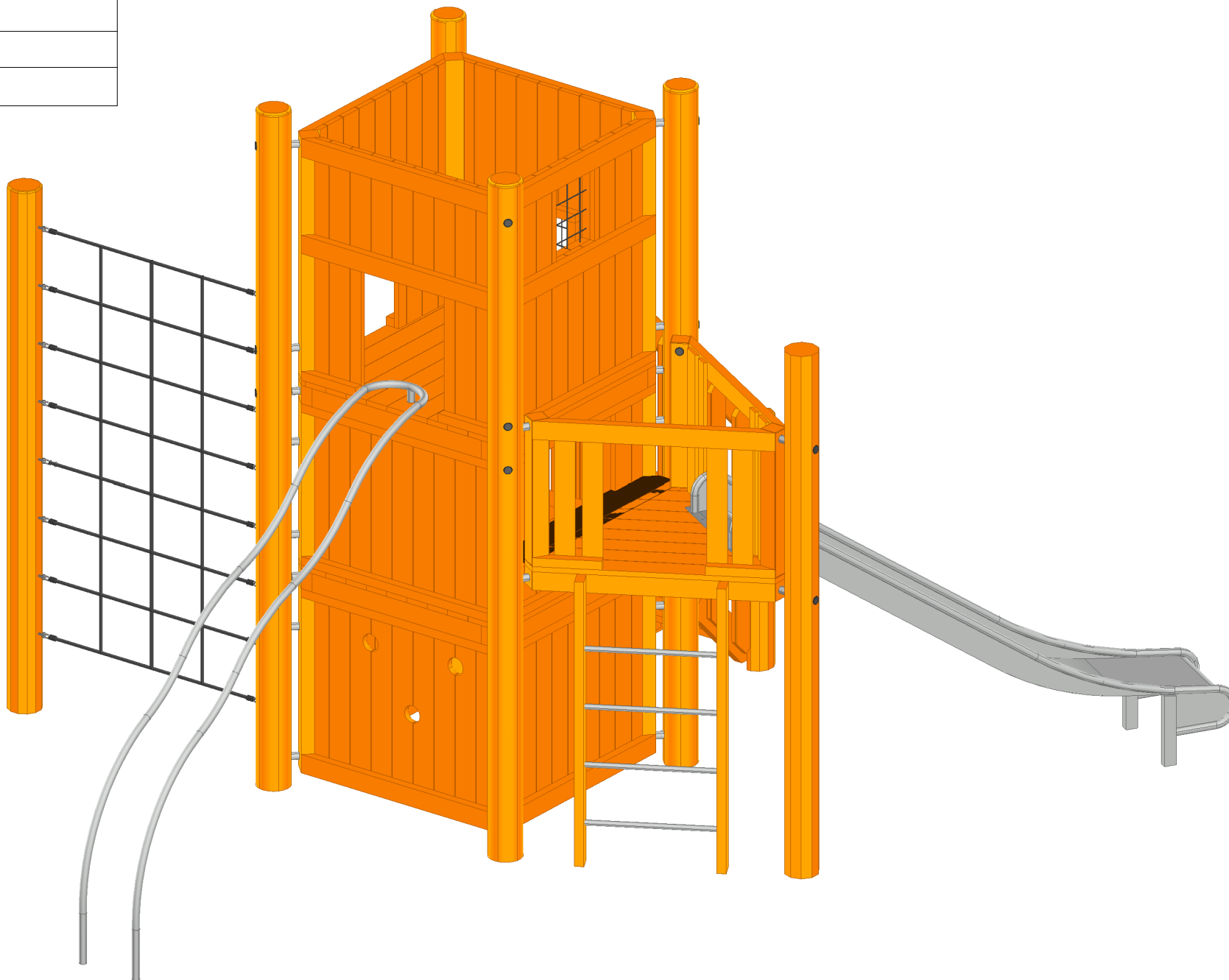

This drawing is the property of NORLEG and pursuant to current legislation may not be copied, transferred to or used by any third party. Should this drawing be used, a fee of 10% of the assumed contract price will be charged.

<b>NORLEG</b>	
Klatresystem Brokk	
Z12711	
Dato 22.06.2017	REV. -

< 2500



≥ EN 1176

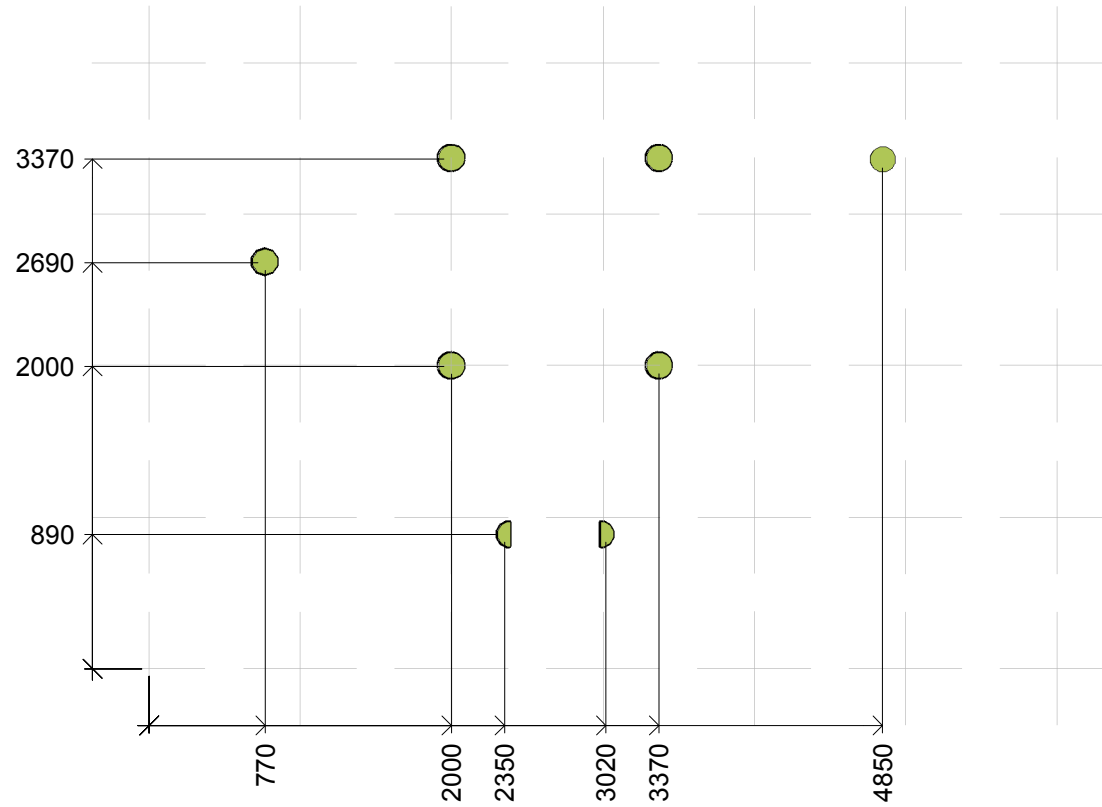
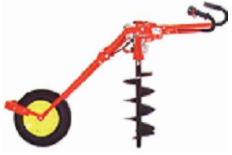

<b>NORLEG</b>	
Klatresystem Brokk	
Z12711	
Dato 22.06.2017	REV. -

< 2500



≥ EN 1176

By assembly. Drilling and use of saw must be expected.

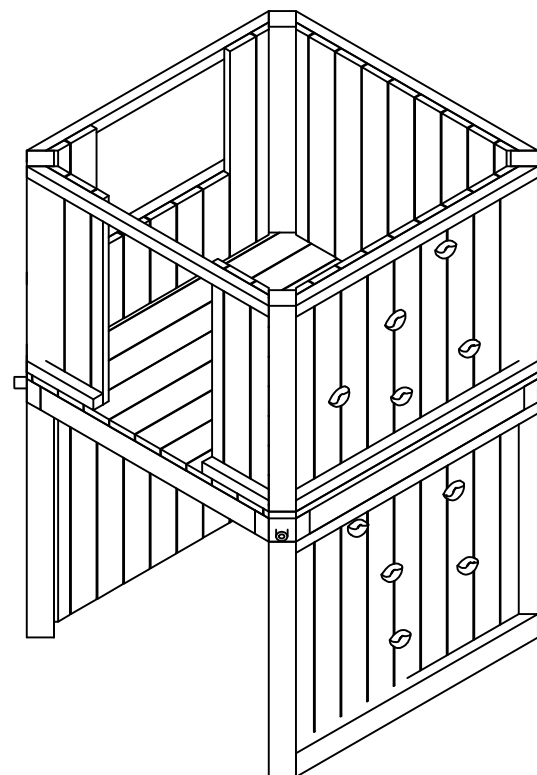
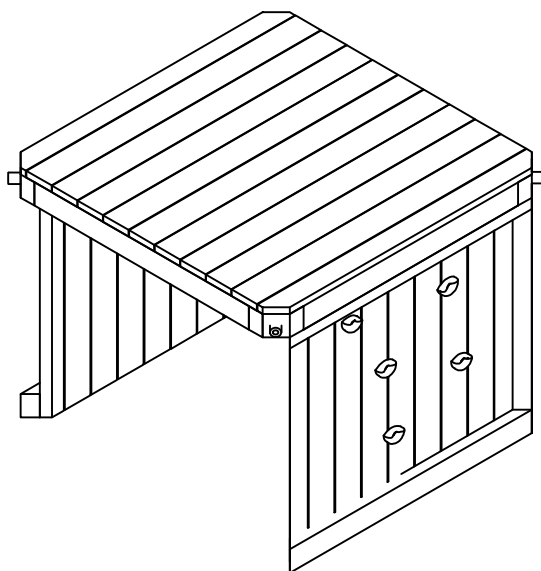

<b>NORLEG</b>	
Klatresystem Brokk	
Z12711	
Dato 22.06.2017	REV. -

< 2500



≥ EN 1176

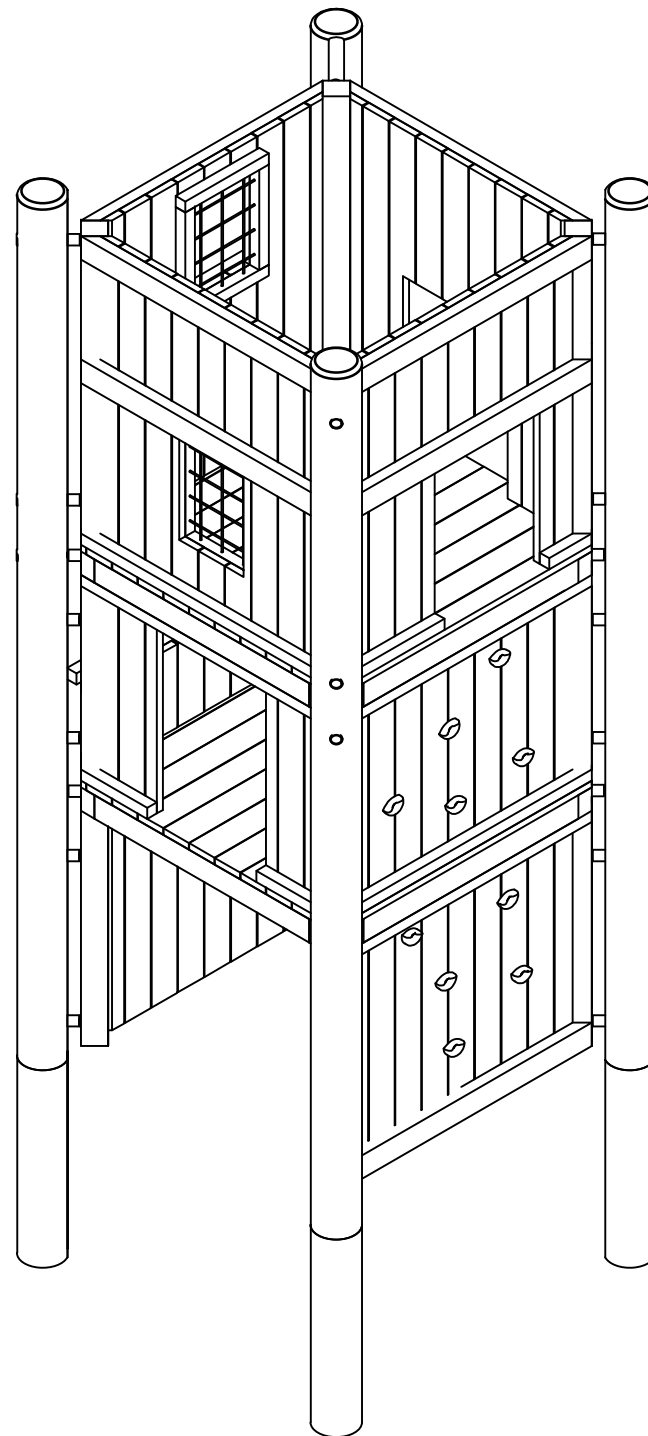
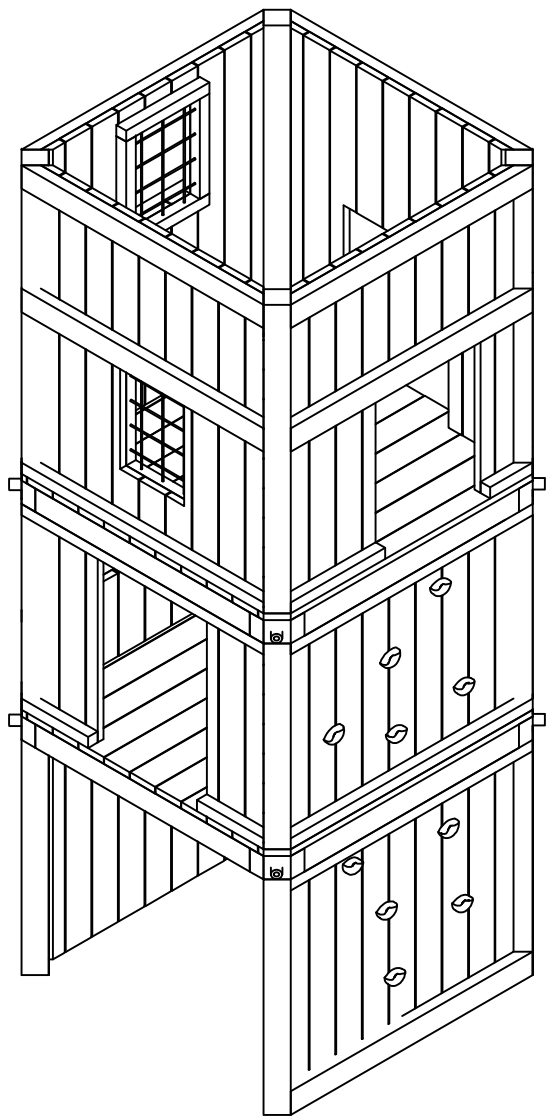

This drawing is the property of NORLEG and pursuant to current legislation may not be copied, transferred to or used by any third party. Should this drawing be used, a fee of 10% of the assumed contract price will be charged.

<b>NORLEG</b>	
Klatresystem Brokk	
Z12711	
Dato 22.06.2017	REV. -

< 2500



≥ EN 1176

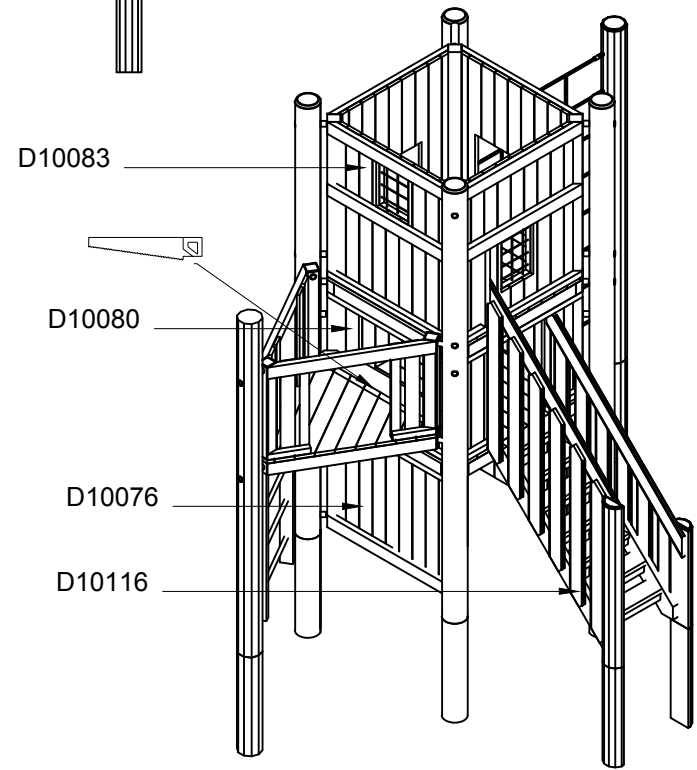
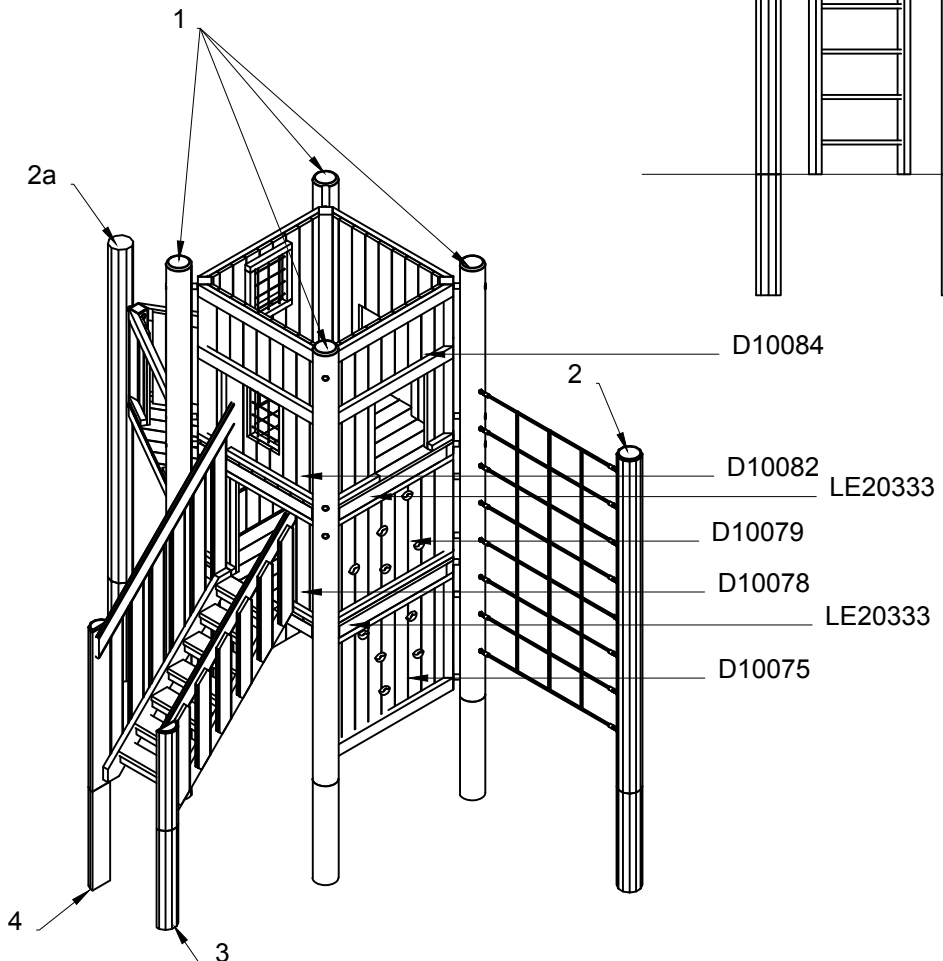
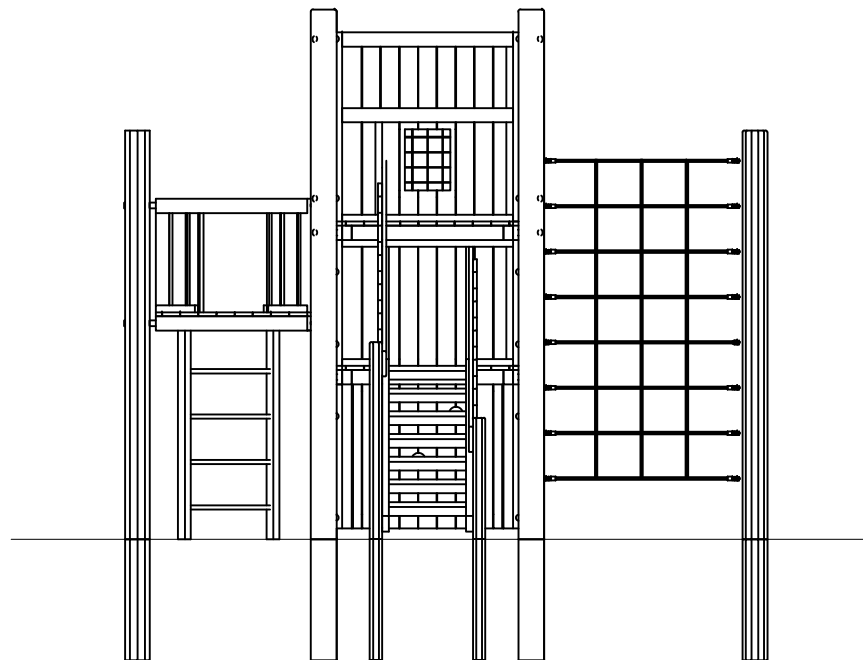

This drawing is the property of NORLEG and pursuant to current legislation may not be copied, transferred to or used by any third party. Should this drawing be used, a fee of 10% of the assumed contract price will be charged.

1:50



<b>NORLEG</b>	
Klatresystem Brokk	
Z12711	
Dato 22.06.2017	REV. -

< 2500



≥ EN 1176

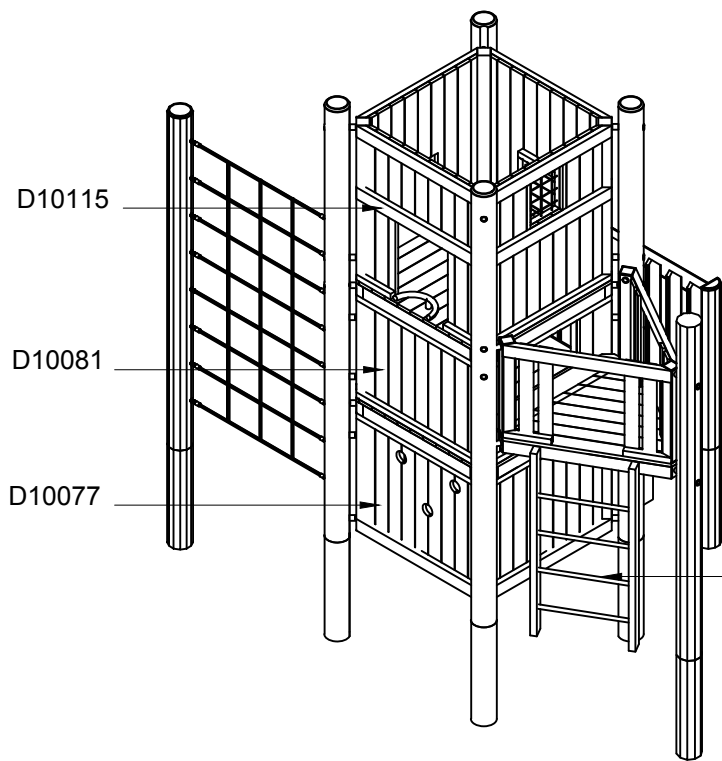
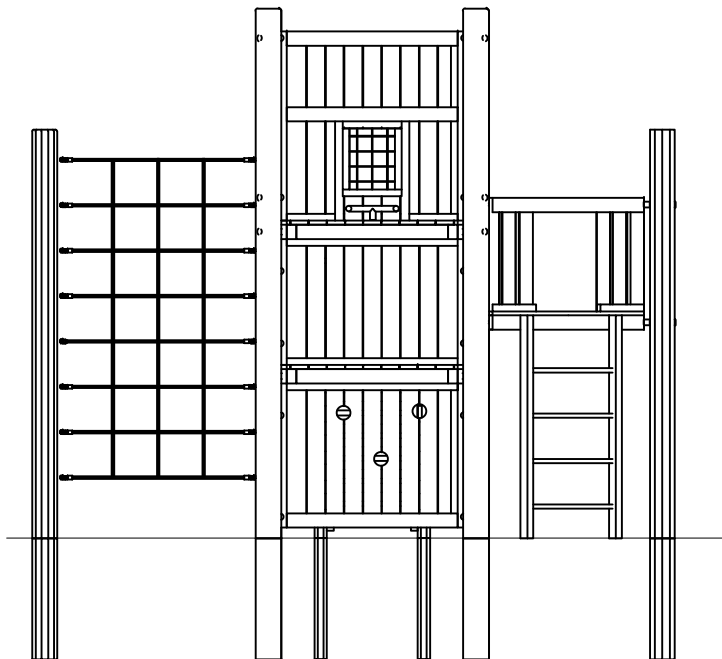

D10117

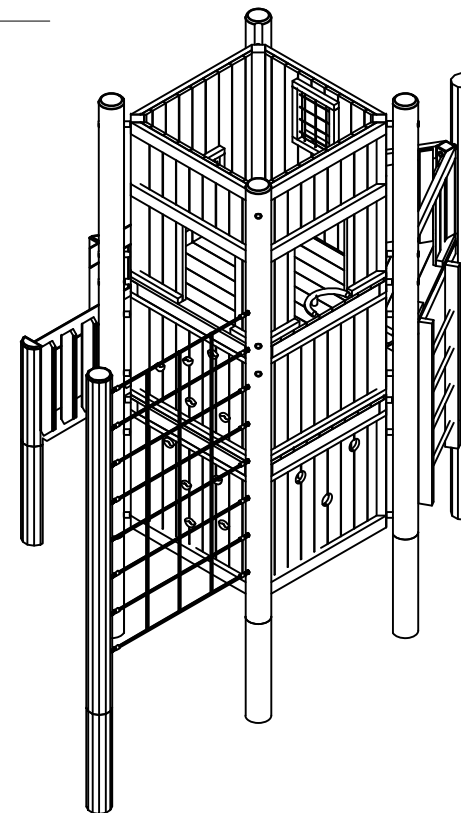

<b>NORLEG</b>	
Klatresystem Brokk	
Z12711	
Dato 22.06.2017	REV. -

< 2500



≥ EN 1176

Mont.p. nr.

- 4
- 19
- 23A
- 27
- 28A
- 52A
- 54A
- 67

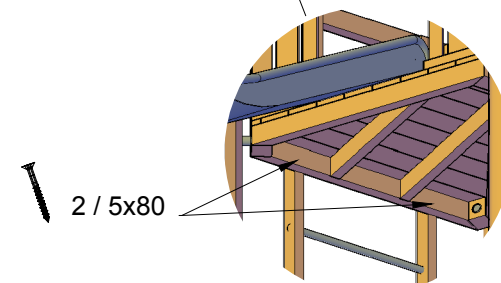
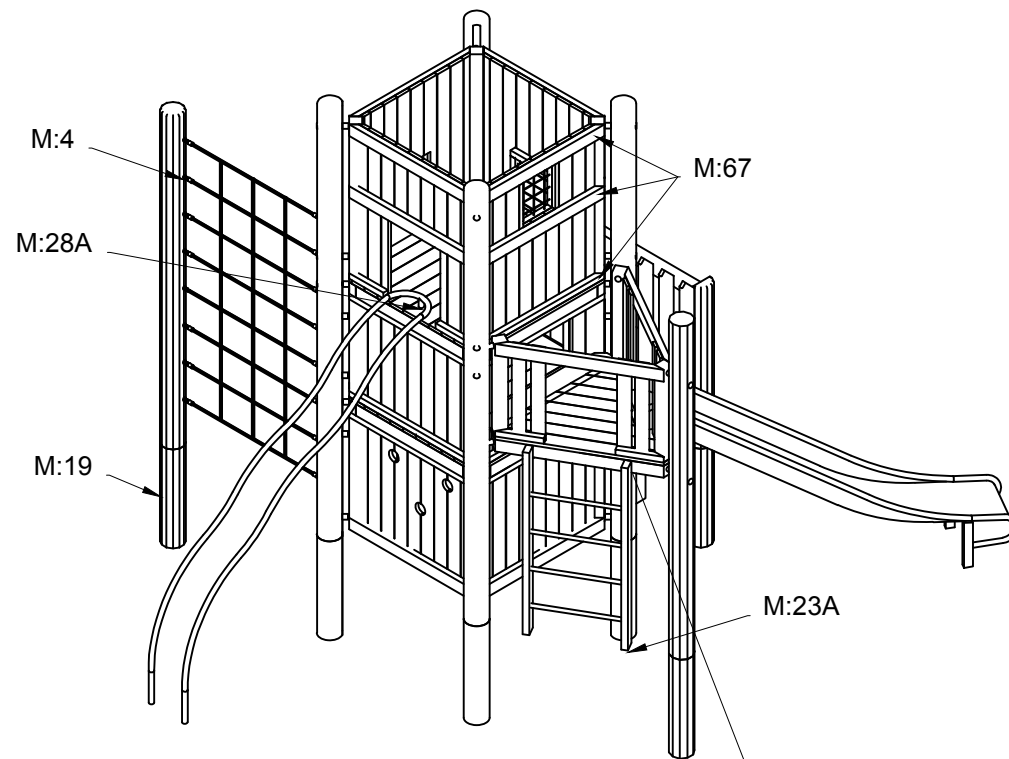
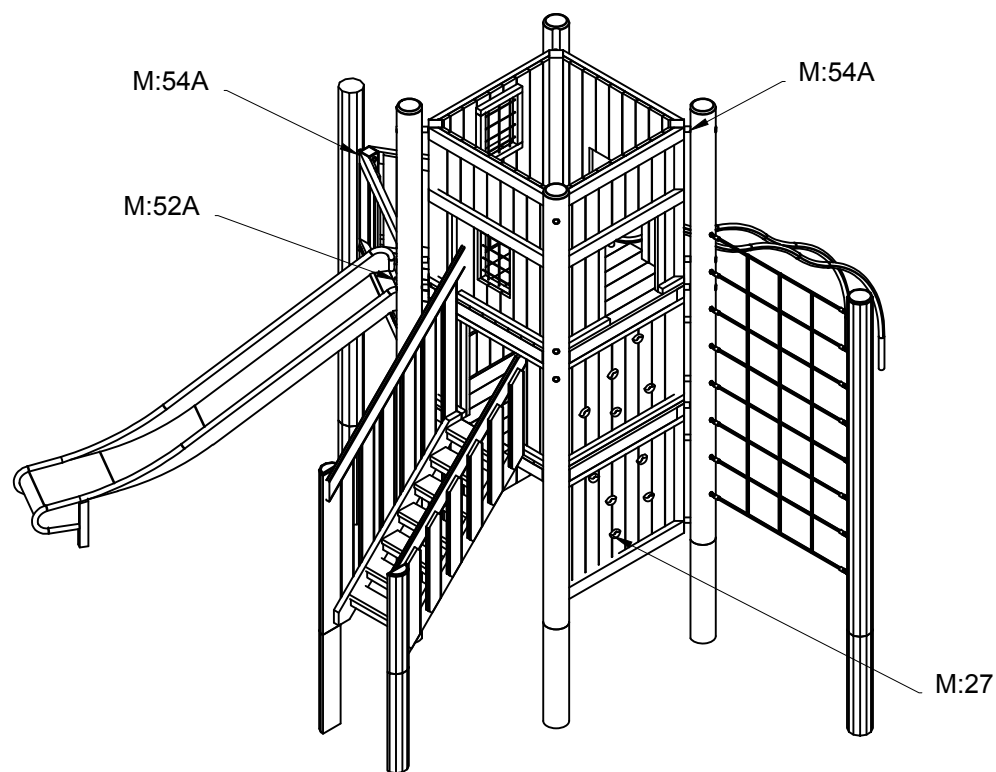

This drawing is the property of NORLEG and pursuant to current legislation may not be copied, transferred to or used by any third party. Should this drawing be used, a fee of 10% of the assumed contract price will be charged.

1:50