

<b>NORLEG</b>	
Klatresystem Vili	
Z12281	
Dato 01.03.2016	REV. -

< 1500

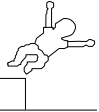

≥ EN 1176

Ijslander rev. 6664

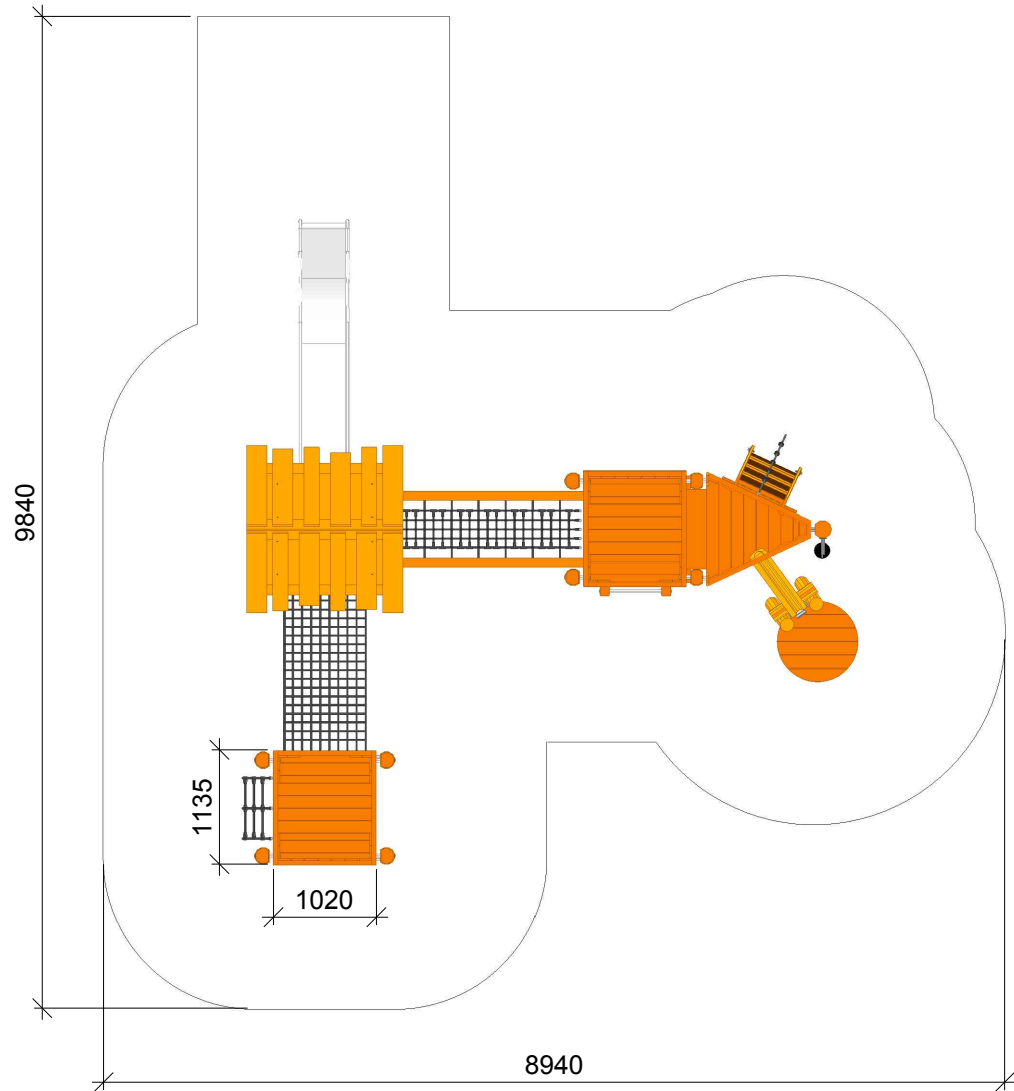
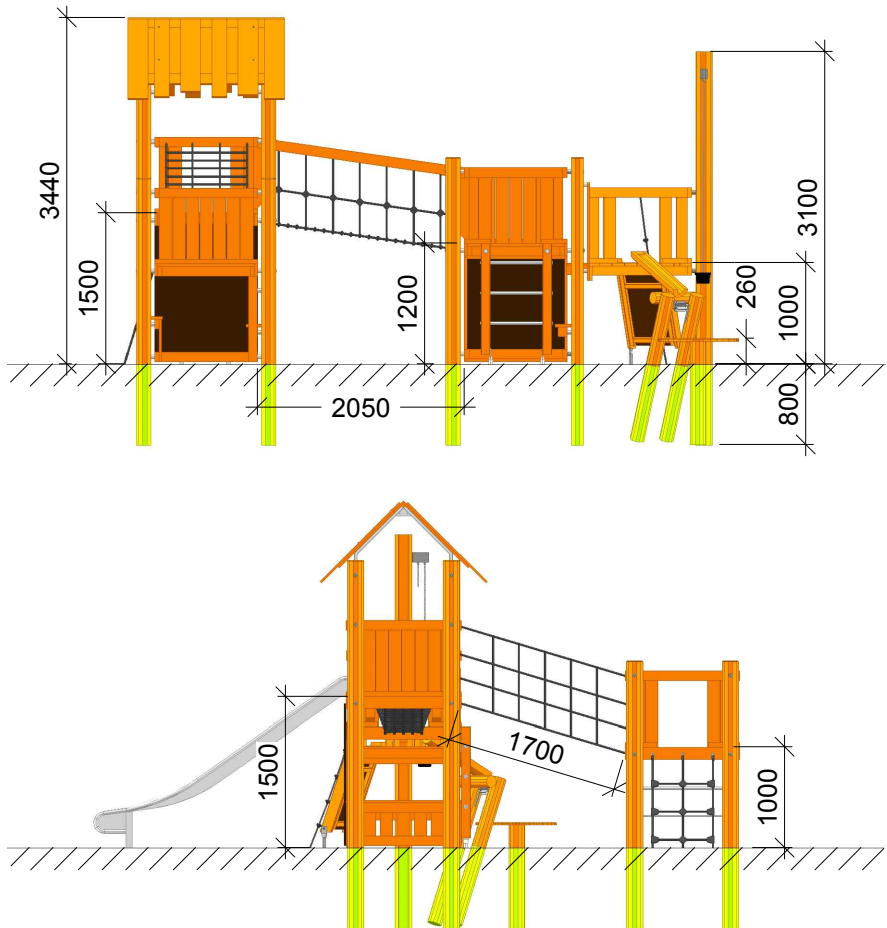

This drawing is the property of NORLEG and pursuant to current legislation may not be copied, transferred to or used by any third party. Should this drawing be used, a fee of 10% of the assumed contract price will be charged.

1:75



Ijslander BV  
 Oude Dijk 10  
 8096 RK Oldebroek | The Netherlands  
 T +31 (0)525 633420 | F +31 (0)525 631067  
 info@ijslander.com | www.ijslander.com

# NORLEG - 3D

## Klatresystem Vili

Z12281

Dato 01.03.2016

REV. -



This drawing is the property of NORLEG and pursuant to current legislation may not be copied, transferred to or used by any third party. Should this drawing be used, a fee of 10% of the assumed contract price will be charged.

# NORLEG - 3D

Klatresystem Vili

Z12281

Dato 01.03.2016

REV. -

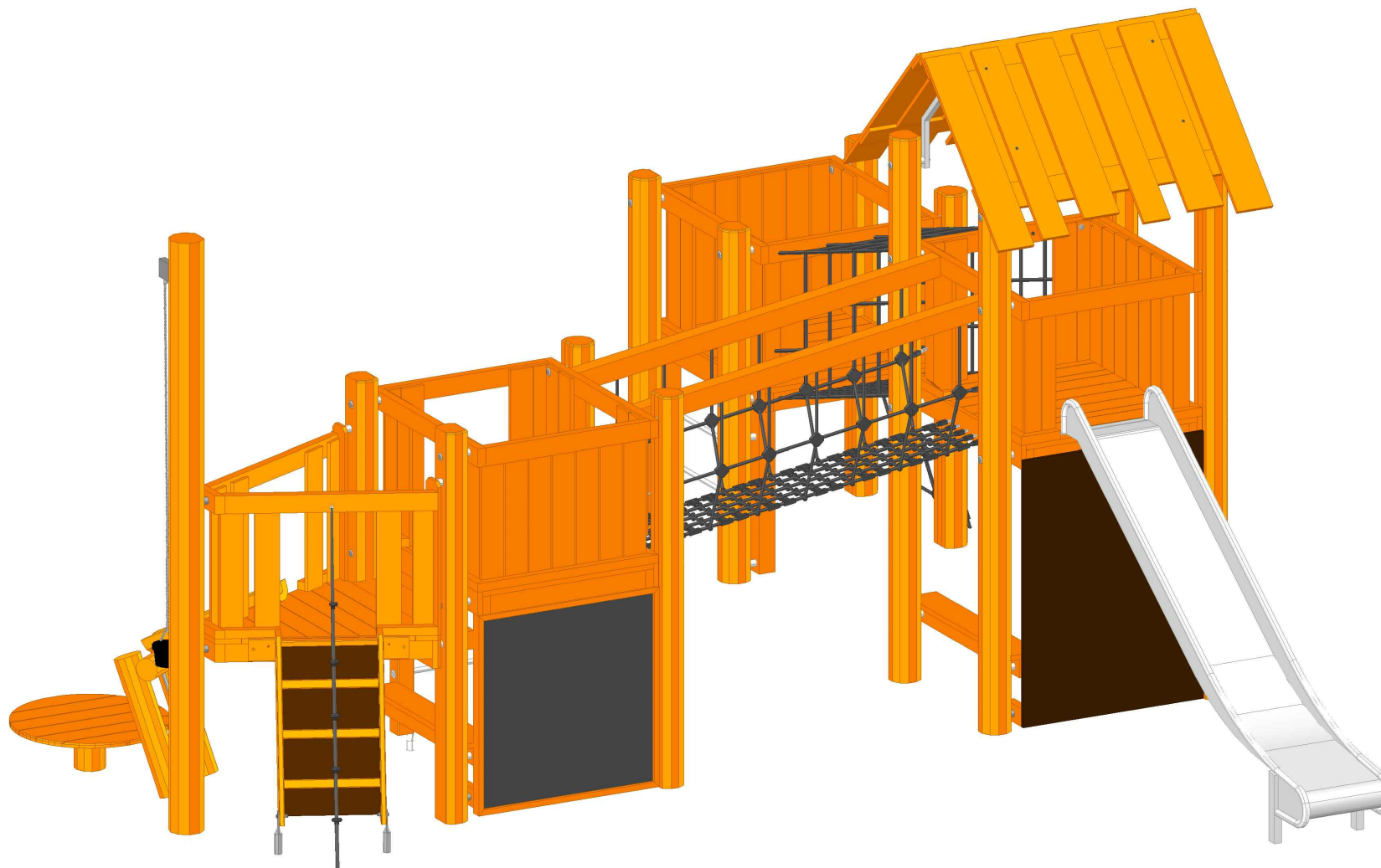

This drawing is the property of NORLEG and pursuant to current legislation may not be copied, transferred to or used by any third party. Should this drawing be used, a fee of 10% of the assumed contract price will be charged.

# NORLEG - 3D

## Klatresystem Vili

Z12281

Dato 01.03.2016

REV. -

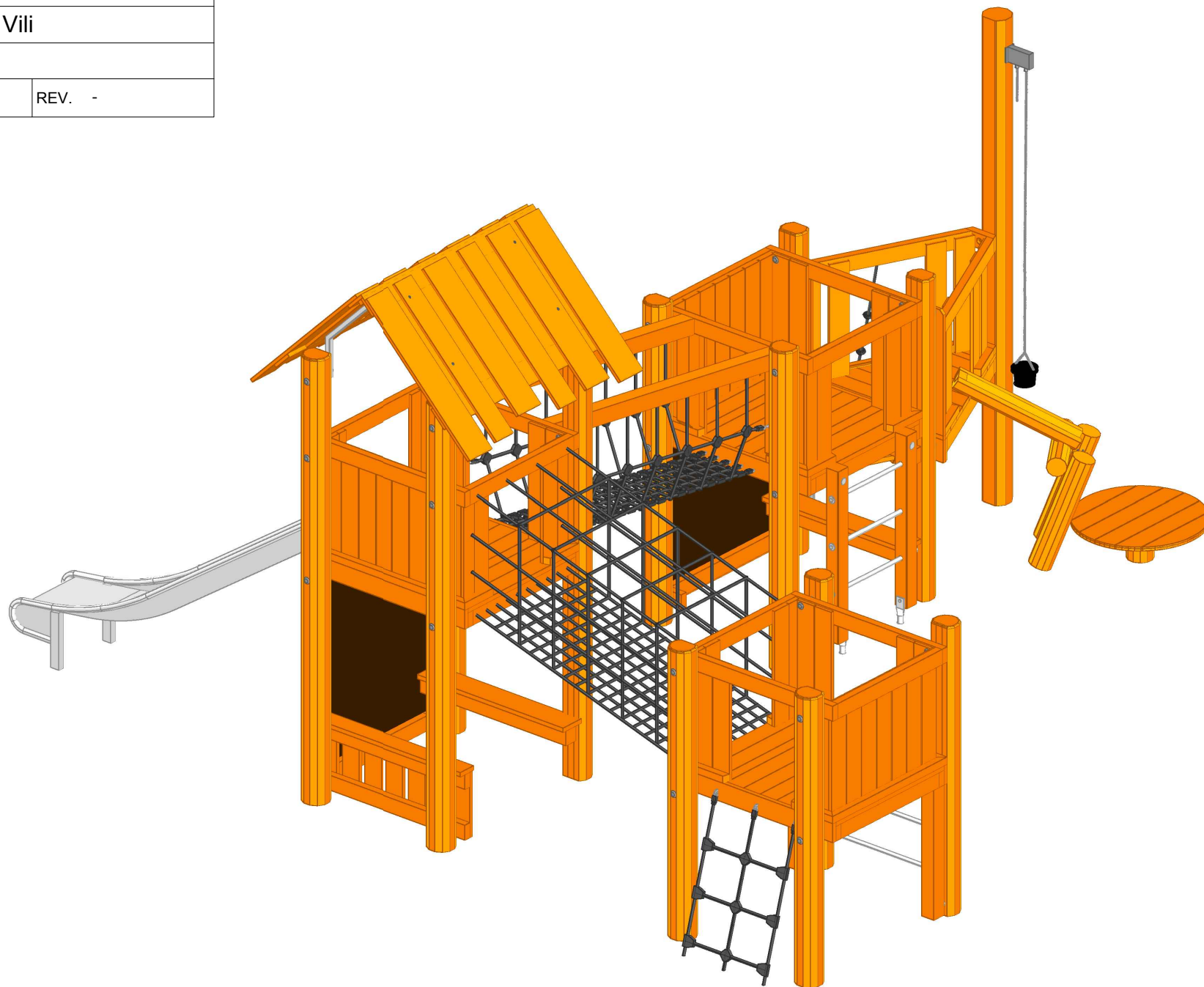

This drawing is the property of NORLEG and pursuant to current legislation may not be copied, transferred to or used by any third party. Should this drawing be used, a fee of 10% of the assumed contract price will be charged.

<b>NORLEG</b> - Mont.	
Klatresystem Vili	
Z12281	
Dato 01.03.2016	REV. -

< 1500

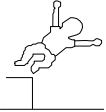

≥ EN 1176

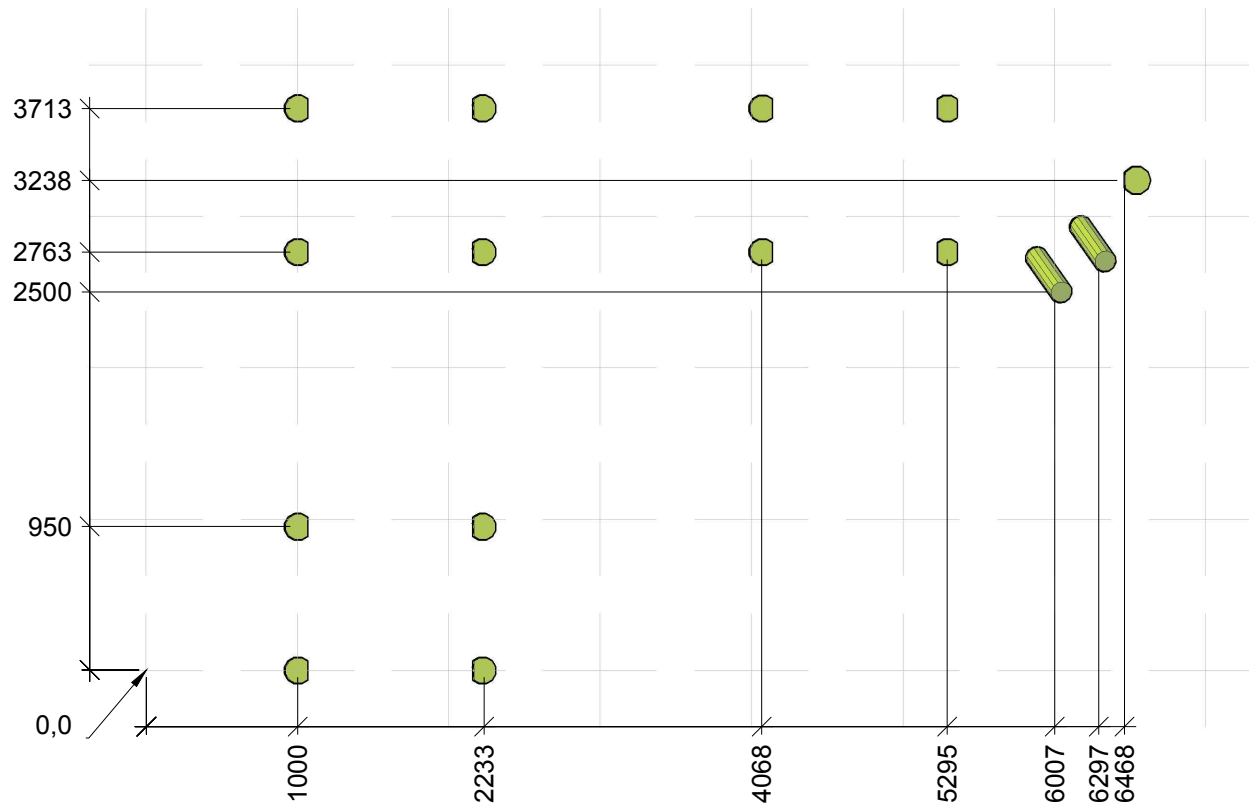

<b>NORLEG</b> - Mont.	
<b>Klatresystem Vili</b>	
Z12281	
Dato 01.03.2016	REV. -

< 1500

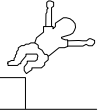

≥ EN 1176

By assembly. Drilling and use of saw must be expected.

Dh = Disk head



Ch = Countersunk head

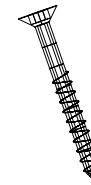

Mont.p. nr.

- 19
- 24
- 62
- 73
- 78
- 99

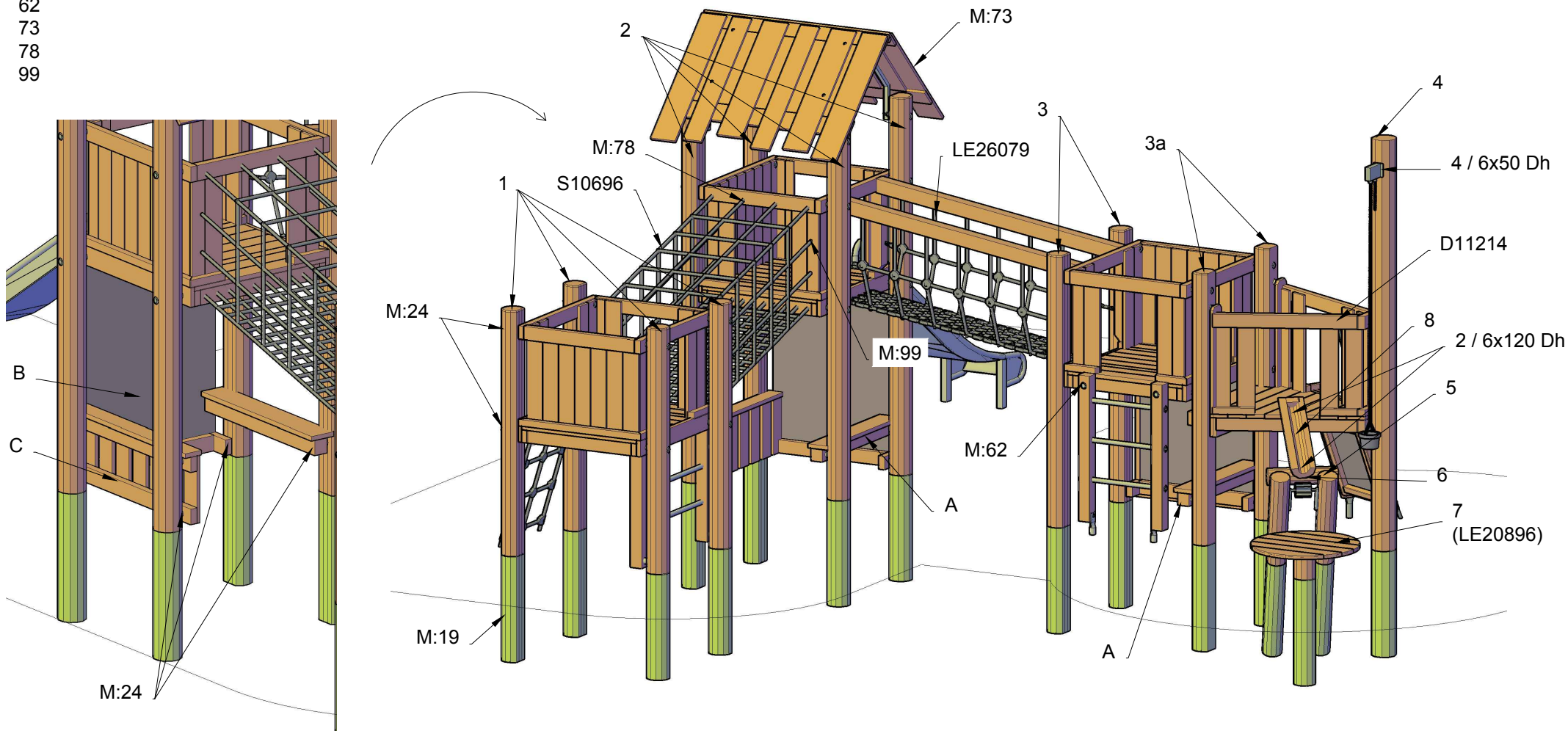

This drawing is the property of NORLEG and pursuant to current legislation may not be copied, transferred to or used by any third party. Should this drawing be used, a fee of 10% of the assumed contract price will be charged.

<b>NORLEG</b> - Mont.	
Klatresystem Vili	
Z12281	
Dato 01.03.2016	REV. -

< 1500

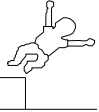

≥ EN 1176

By assembly. Drilling and use of saw must be expected.

Dh = Disk head

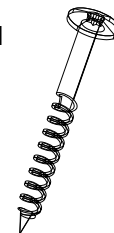

Ch = Countersunk head

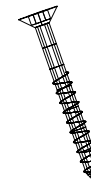

Mont.p. nr.

- 4A
- 24
- 52A
- 70
- 78

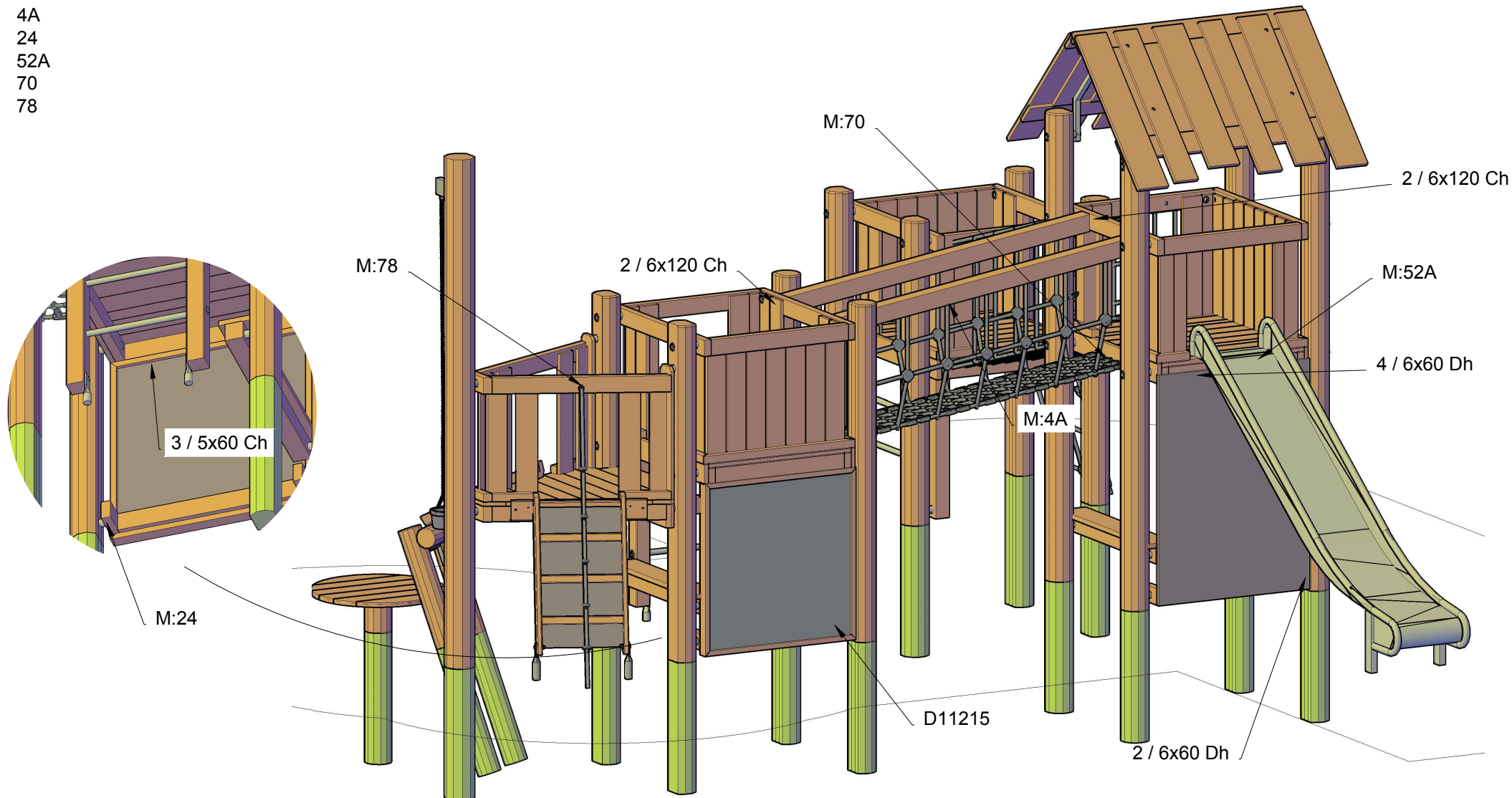

This drawing is the property of NORLEG and pursuant to current legislation may not be copied, transferred to or used by any third party. Should this drawing be used, a fee of 10% of the assumed contract price will be charged.

<b>NORLEG</b>		
<b>Klatresystem Vili</b>		
Z12281	Tegner HS	Godkendt af -
Dato 01.03.2016	REV. -	

Parts list

Mrk.	QTY	Part.no	Gulvhøjde	TB-skabelon
1	4	160-180-2650-k-f	1000	3,4
2	4	160-180-3650-k-f	1500	3,4,6
3	2	160-180-2850-k-f	1200	3,4
3a	2	160-180-2850-d [120]-f	1200	3,4
4	1	140-160-3900-f	1000	3,4
5	2	120-140-1530		
6	1	100-120-520		
7	1	LE20896		
8	1	Vandrende L=800		Bredde gerne < 220 ved udløb

k = Kantskåret  
 d = Dobbeltskåret  
 v = Vinkelskåret  
 h = Halvskåret  
 t = k på 3 sider  
 z = Speciel - se detalje  
 f = Forboring + montering  
 TB=skabelon for tårmben

Denne tegning er NORLEG's ejendom, og må ifølge gældende lov ikke kopieres, overlades eller udnyttes af 3. mand. Sker dette, skal det påregnes, at der vil blive opkrævet et honorar på 10% af formodet entreprisum.

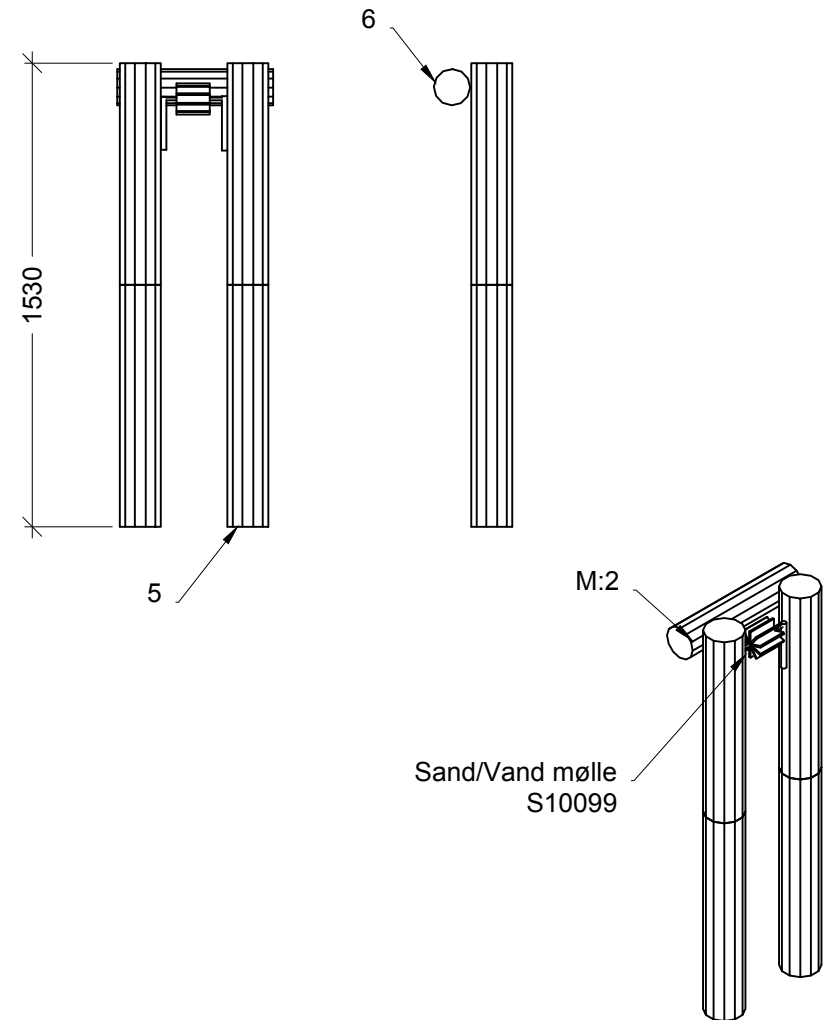



<b>NORLEG</b>		
<b>Klatresystem Vili</b>		
Z12281	Tegner HS	Godkendt af -
Dato 01.03.2016	REV. -	

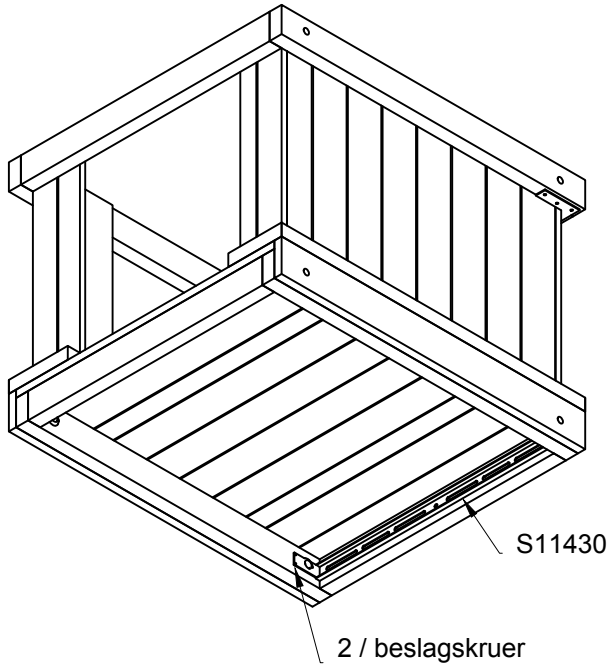

Forstærkning af tårnkasser  
for nettunnel

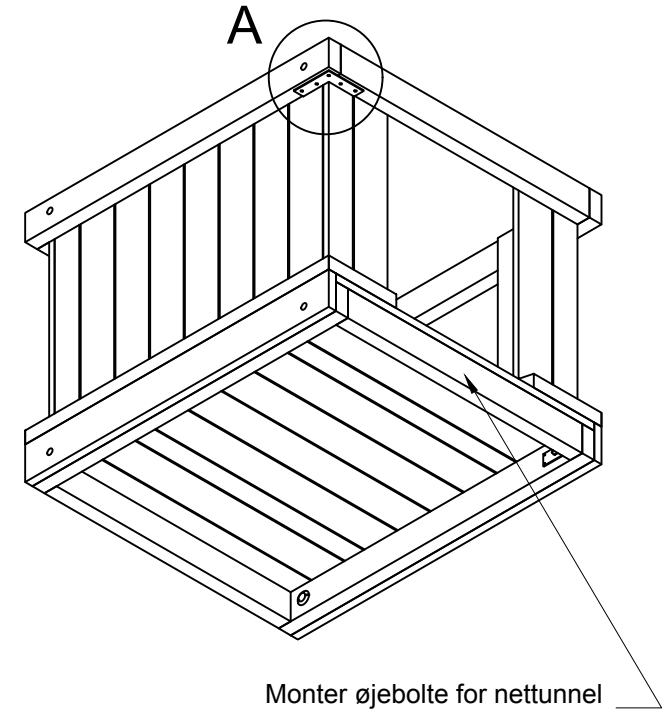
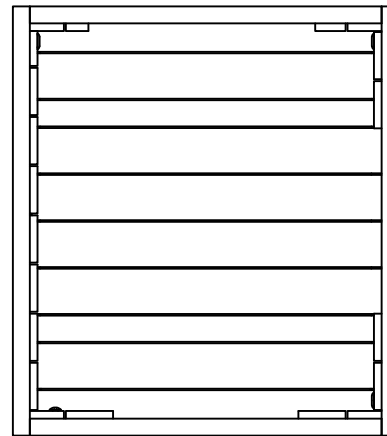
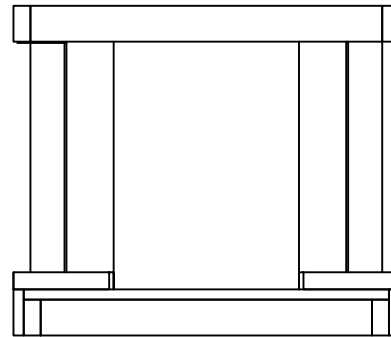

A (1:10)

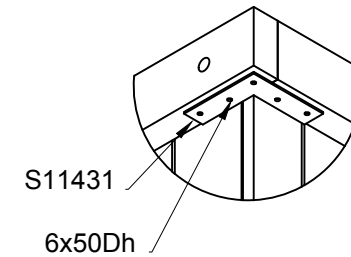

<b>NORLEG</b>		
<b>Klatresystem Vili</b>		
Z12281	Tegner HS	Godkendt af -
Dato 01.03.2016	REV.	-

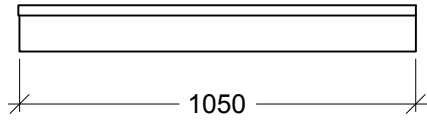

Mrk.A  
x 2

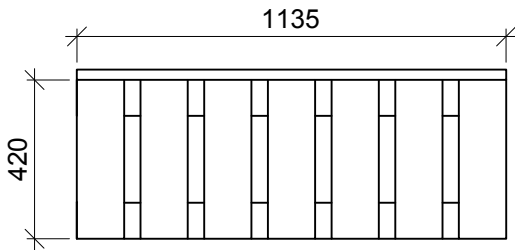
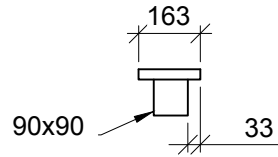

Mrk.C

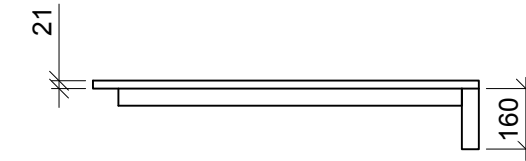
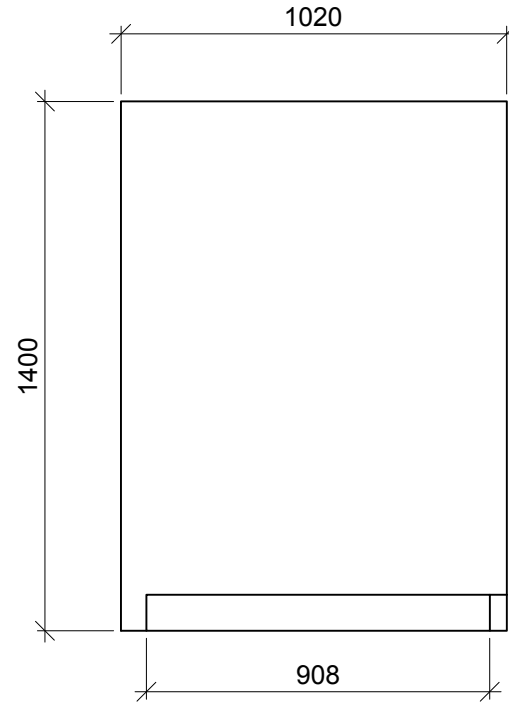
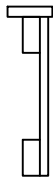

Mrk.B

