

All rights reserved. Reproduction or distribution of this drawing without the written authority of the proprietor is prohibited.

Alle rechten voorbehouden. Verspreiding of nabereiking van tekeningen in welke vorm ook, is zonder schriftelijke toestemming van de afzender niet geoorloofd.

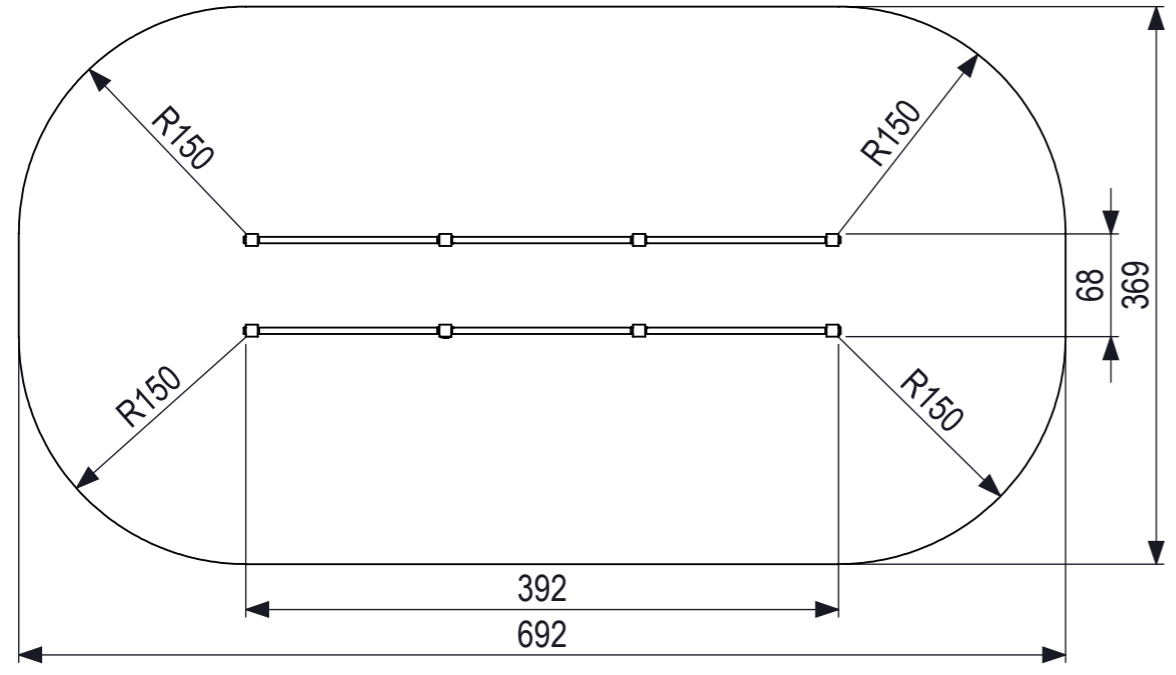

Bevestiging d.m.v. inbusbout weggewerkt in gietdelen.

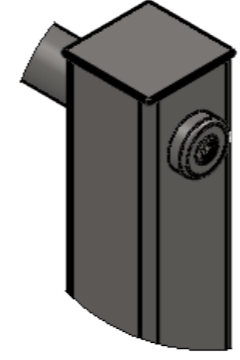

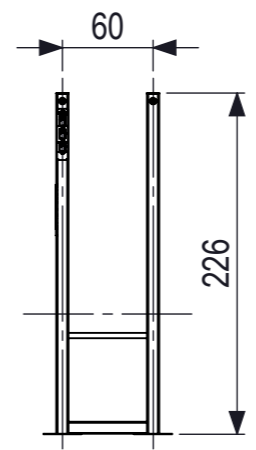
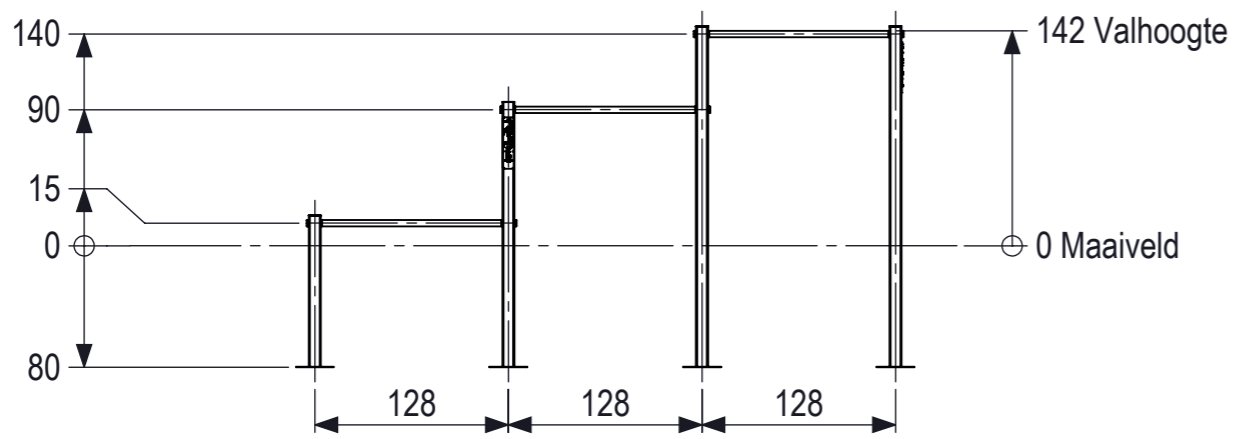
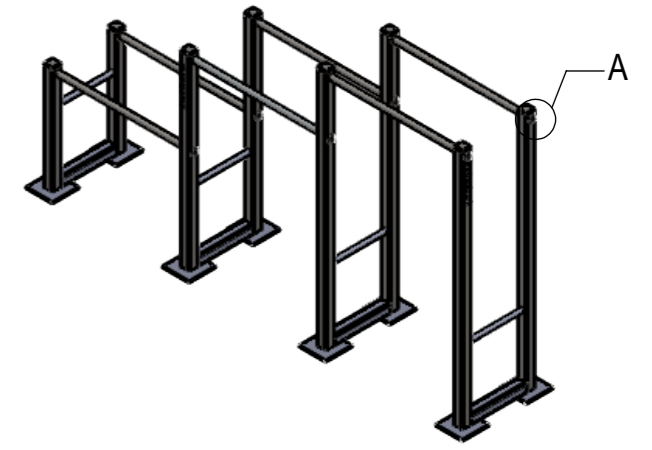

DETAIL A
SCALE 1 : 5

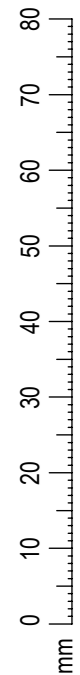

Onder voorbehoud van de TÜV
Under condition of the TÜV approval



 IJSLANDER		IJslander BV Oude Dijk 10 8096 RK Oldebroek The Netherlands T +31 (0)525 633420 F +31 (0)525 631067 info@ijslander.com www.ijslander.com		benaming/name <h3>BarForz Combi Bar</h3>			
		proj. 	eenheid/unit cm	getekend/drawn JdJ	datum/date 19-6-2020	naam/name JdJ	paraaf/signature
schaal/scale 1:50	tekeningnummer/drawingnumber 1641-INS			blad/sheet 1 - 1	wijz./rev. -	form./size A3	