

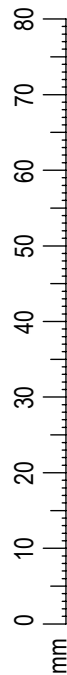

 <p>Ijlander BV Oude Dijk 10 8096 RK Oldebroek The Netherlands T +31 (0)525 633420 F +31 (0)525 631067 info@ijlander.com www.ijlander.com</p>	oppervlakte ruwheid surface roughness DIN ISO 1302		alg. ruwheid gen. roughness 3,2	eenheid/unit mm	datum date 19-7-2021	naam name AW		
	vorm- en plaatstoleranties geometrical tolerancing DIN ISO 1101		alg. toleranties gen. tolerancing DIN 7168-m	toelaatbare afwijkingen voor lineaire maten (m.u.v. gebroken kanten) admissible deviations for linear dimensions (excepting broken edges)				
lineaire maat linear dimension		> 0,5 ≤ 6		6 30 120 400 1000 2000 4000 8000	afwijking/deviation ±0.1 ±0.2 ±0.3 ±0.5 ±0.8 ±1.2 ±2 ±3			
Totaal gewicht: 45,51 kg		Zwaarste onderdeel: 45,51 kg		Leeftijd van: - jaar			Valondergrond klasse: B - Minimaal natuurlijke bodem benodigd	
proj. 		benaming/name Bakglijbaan H=60cm B=45cm D=2,5mm - richtingloos geborsteld		tekeningnummer/drawingnumber 1148-60-45-2,5-B-INS		blad/sheet 1 - 2	wijz./rev. 00	form./size A3

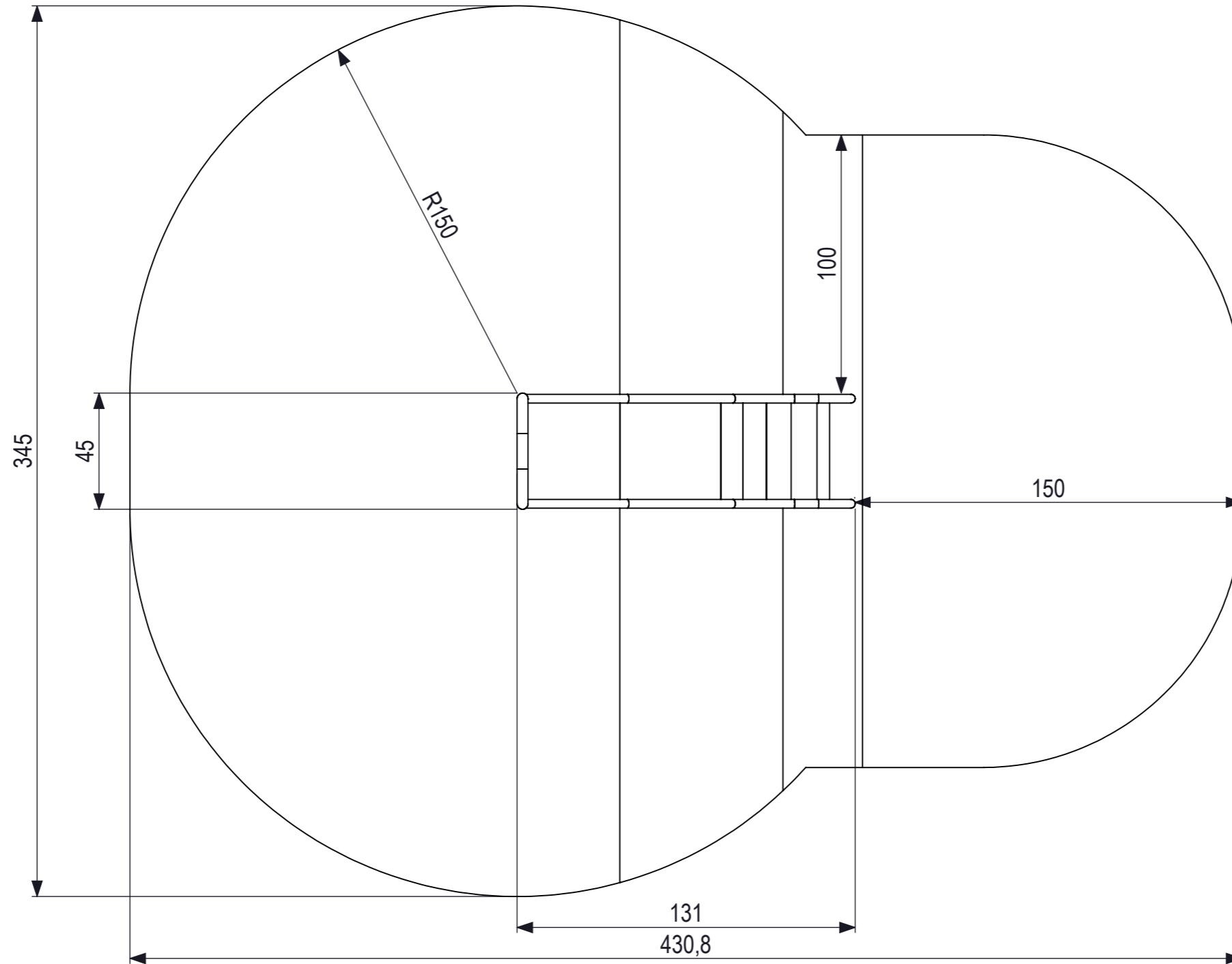

Vrije ruimte
 Vrij zijn van obstakels en looproutes
 Bedekt zijn met valdempende ondergrond geschikt voor een vrije valhoogte van 1m

 IJSLANDER Ijlander BV Oude Dijk 10 8096 RK Oldebroek The Netherlands T +31 (0)525 633420 F +31 (0)525 631067 info@ijlander.com www.ijlander.com	oppervlakte ruwheid surface roughness DIN ISO 1302	alg. ruwheid gen. roughness 3.2	eenheid/unit mm	datum date 19-7-2021	naam name AW
	vorm- en plaatstoleranties geometrical tolerancing DIN ISO 1101	alg. toleranties gen. tolerancing DIN 7168-m	toelaatbare afwijkingen voor lineaire maten (m.u.v. gebroken kanten) admissible deviations for linear dimensions (excepting broken edges)		
proj. 		benaming/name Bakglijbaan H=60cm B=45cm D=2,5mm - richtingloos geborsteld		Totaal gewicht: 45.51 kg Zwaarste onderdeel: 45,51 kg	Leeftijd van: - jaar Valondergrond klasse: B - Minimaal natuurlijke bodem benodigd
schaal/scale 1:20		tekeningnummer/drawingnumber 1148-60-45-2,5-B-INS		blad/sheet 2 - 2	wijz./rev. 00
				form./size A3	