

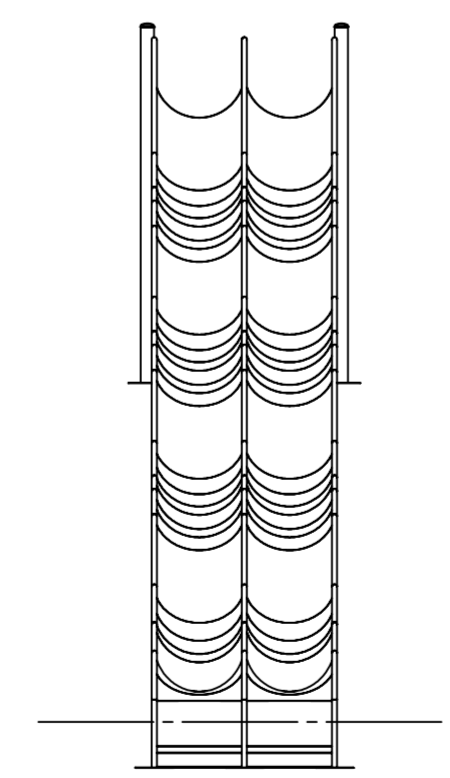

Dit document is auteursrechtelijk beschermd. Het verspreiden of kopiëren van dit document is strafbaar. Het verspreiden of kopiëren van dit document is strafbaar. Het verspreiden of kopiëren van dit document is strafbaar.

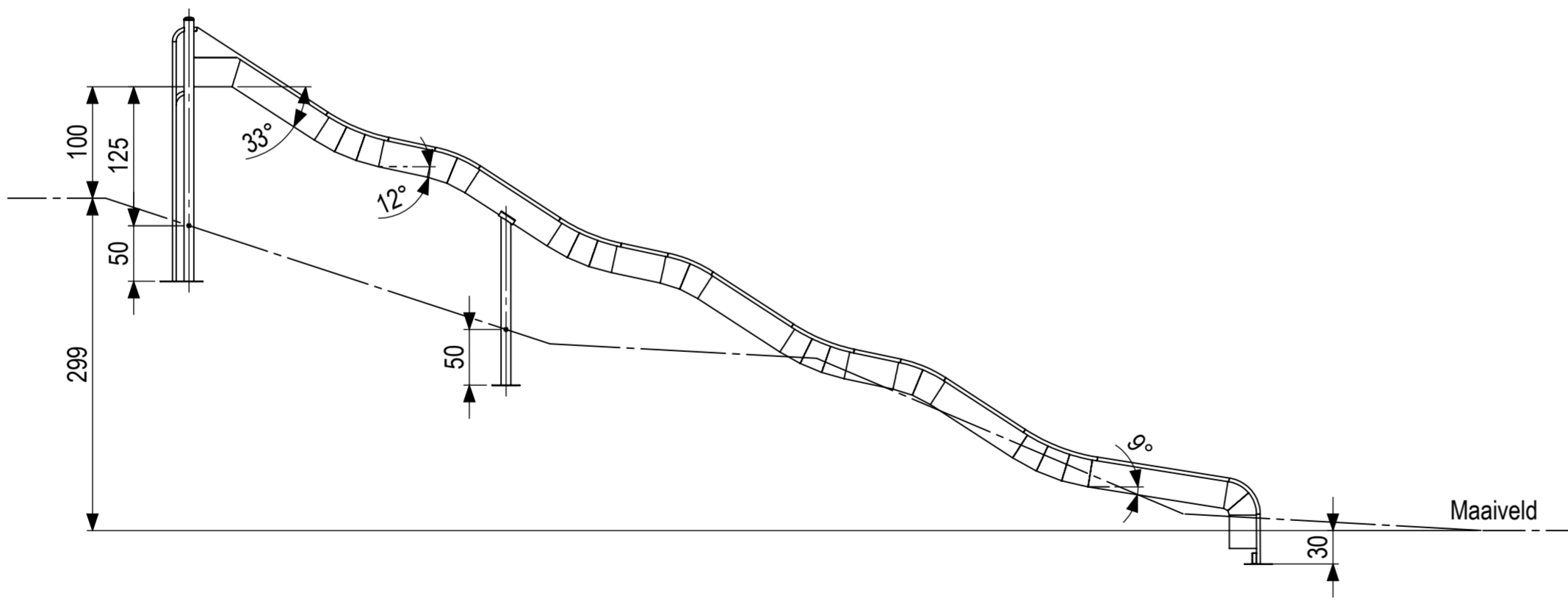
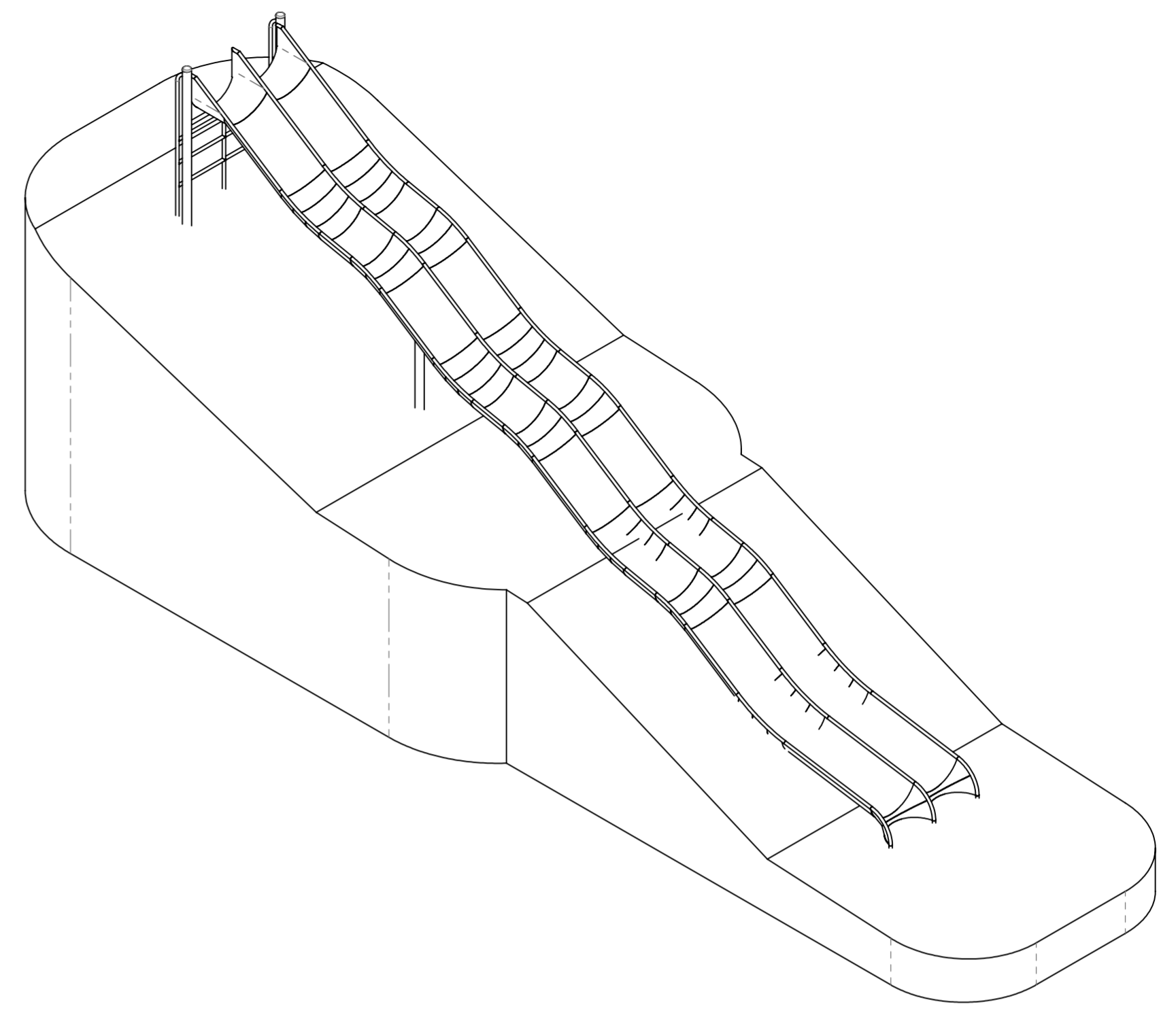
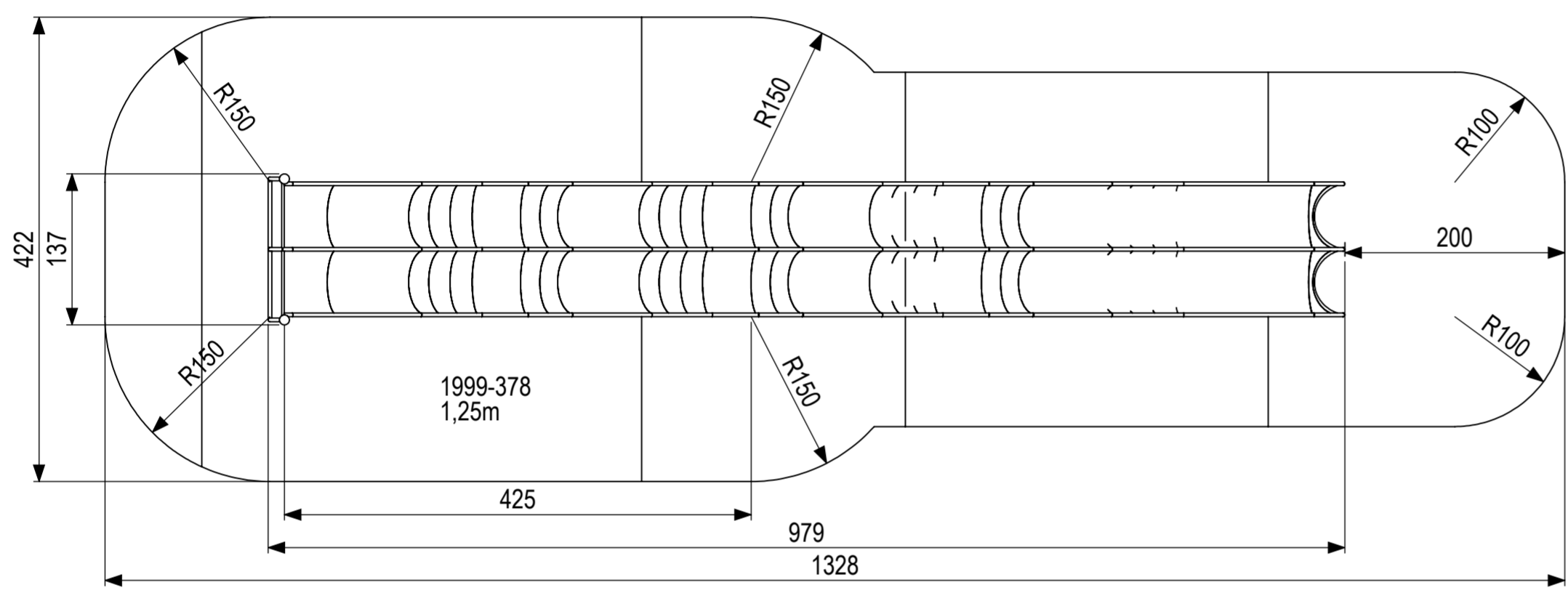
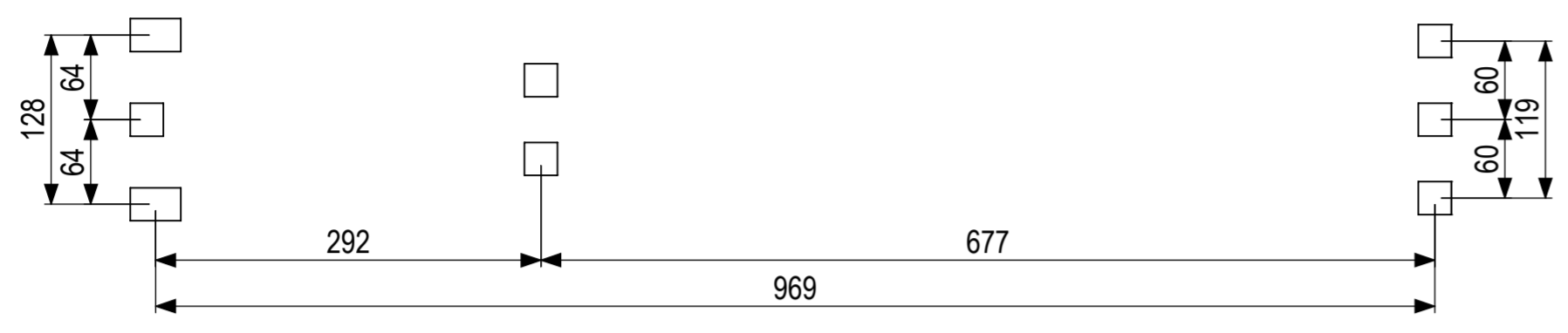

0 10 20 30 40 50 60 70 80 mm

 IJSLANDER IJSLANDER BV Oude Dijk 10 8096 RK Oldebroek The Netherlands T +31 (0)525 633420 F +31 (0)525 631067 info@ijslander.com www.ijslander.com		benaming: Dubbele taludglijbaan H=4m			
proj. 	eenheid/unit: cm	datum: 10-11-2017	naam: PT	status:	
schaal/scale: 1:50	tekeningnummer/drawingnumber: 1999-378-INS	blad/sheet: 1-1	wijz./rev.: -	form./size: A2	