

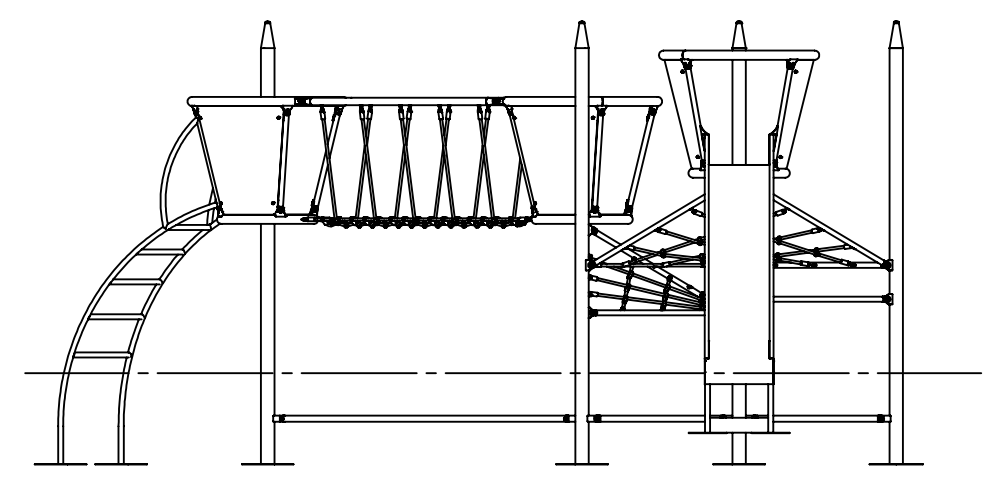

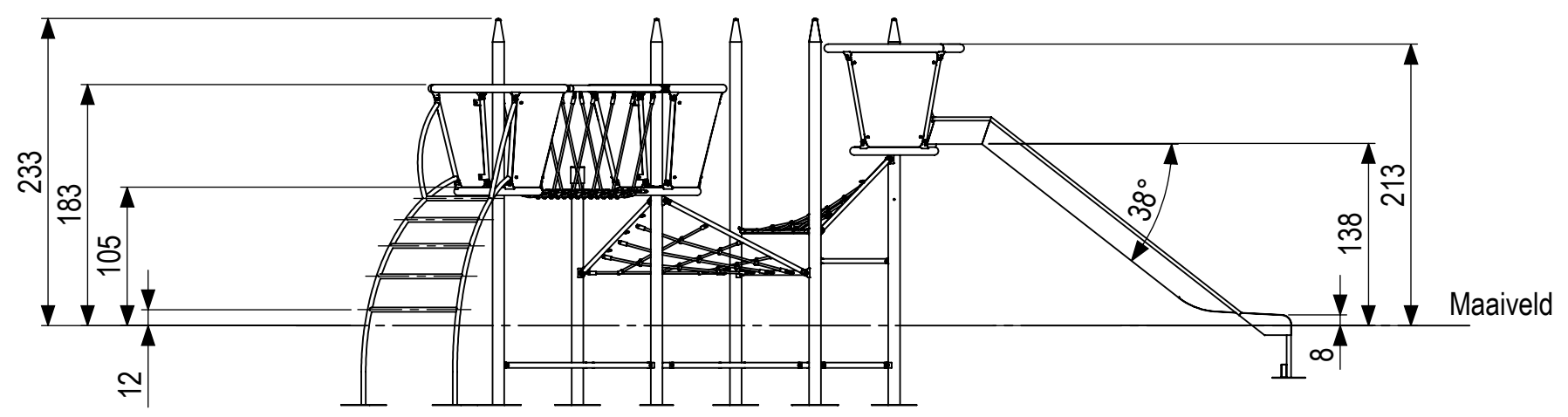

Dit document is auteursrechtelijk beschermd. Het verspreiden of kopiëren van dit document is strafbaar. Het verspreiden of kopiëren van dit document is strafbaar. Het verspreiden of kopiëren van dit document is strafbaar.

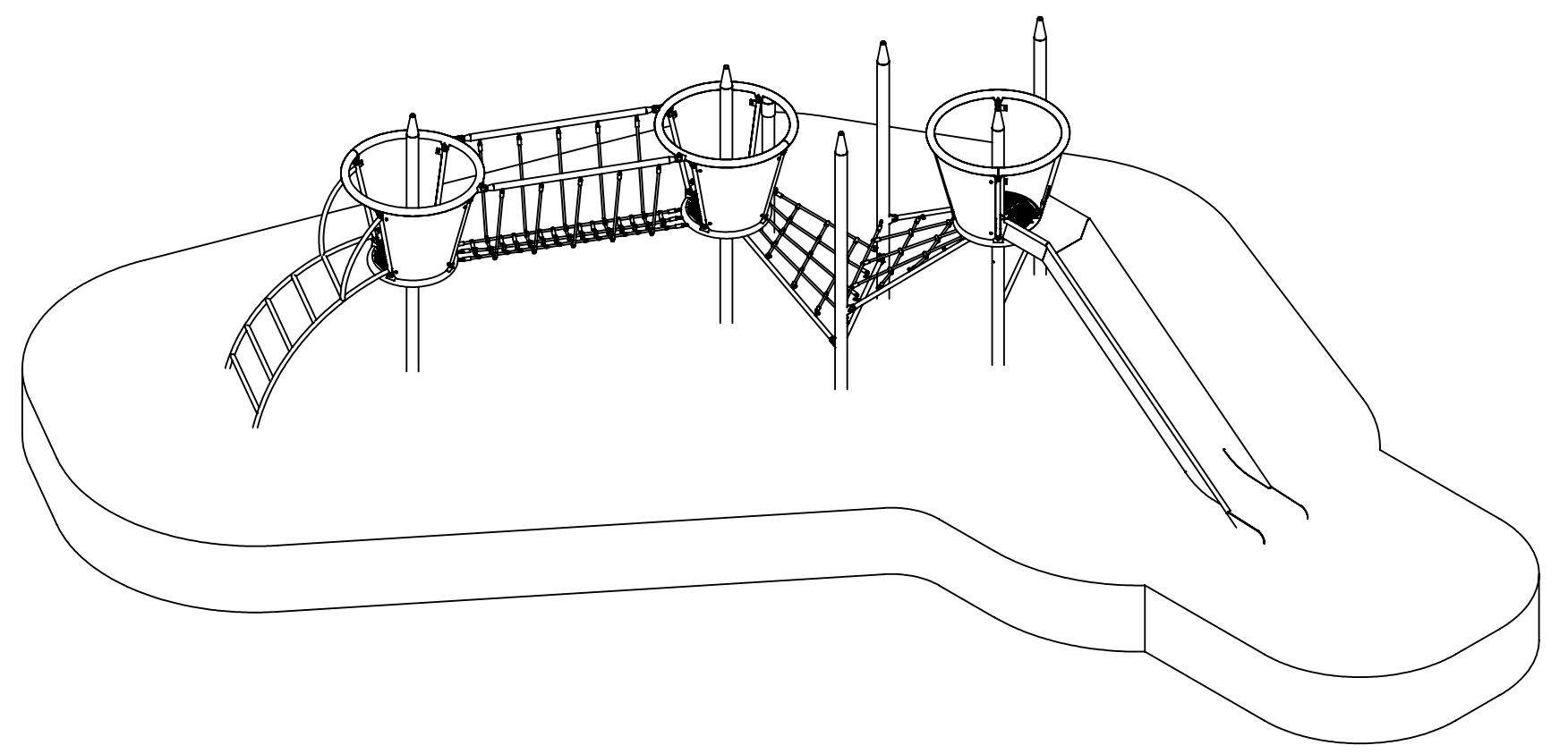
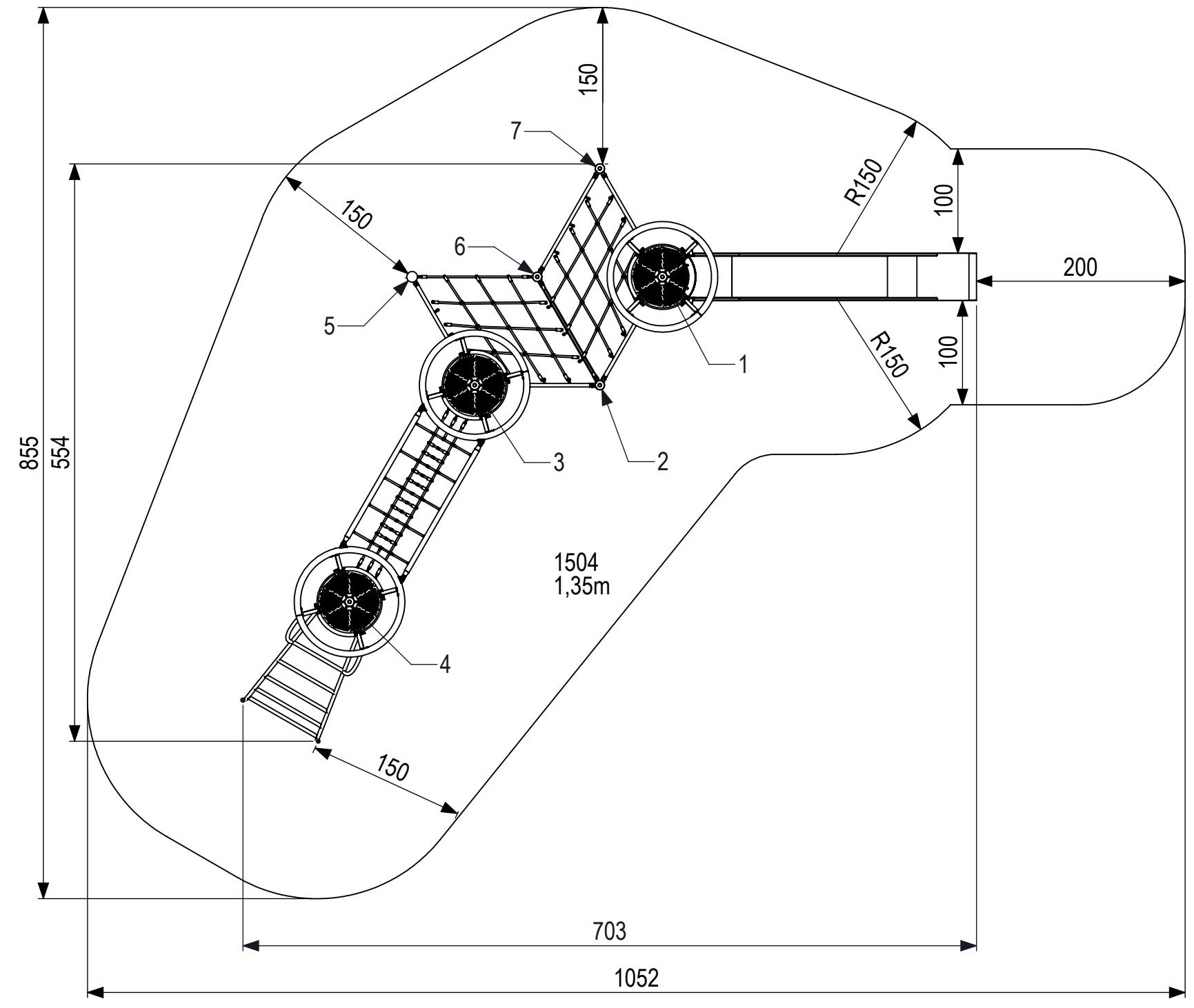

0 10 20 30 40 50 60 70 80 mm

		IJSLANDER BV Oude Dijk 10 8096 RK Oldebroek The Netherlands T +31 (0)525 633420 F +31 (0)525 631067 info@ijslander.com www.ijslander.com		benaming/name Potloodtoestel 4	
proj. 	eenheid/unit cm	datum/date 14-4-2016	naam/nome PT	paraaf/signature 	schaal/scale 1:50
tekeningnummer/drawingnumber 1504A-INS		blad/sheet 1-2		wijz./rev. form./size - A2	

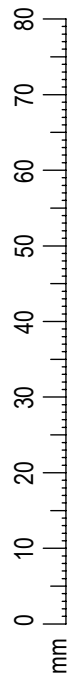
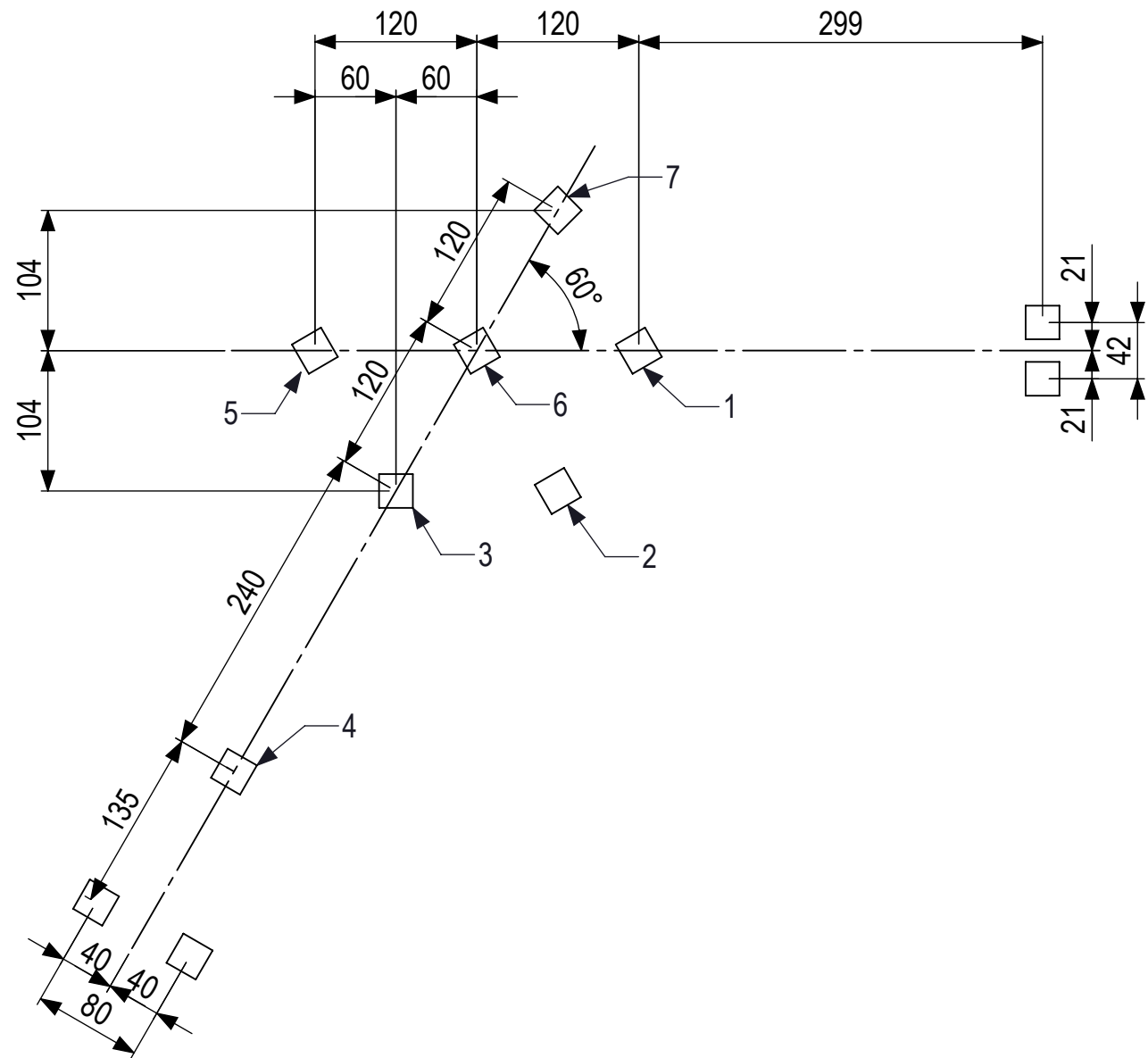

IJSLANDER

IJslander BV
 Oude Dijk 10
 8096 RK Oldebroek | The Netherlands
 T +31 (0)525 633420 | F +31 (0)525 631067
 info@ijslander.com | www.ijslander.com

benaming/name						Potloodtoestel 4		
proj.	eenheid/unit	getekend/drawn	datum/date	naam/name	paraaf/signature			
	CM		14-4-2016	PT				
schaal/scale	tekeningnummer/drawingnumber		blad/sheet	wijz./rev.	form./size			
1:50	1504A-INS		2 - 2	-	A3			